

Panasonic®

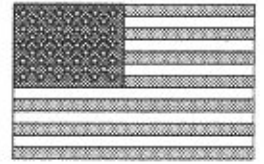

Operating Instructions

Microwave Oven

Model - NN-S780BA/BAS/WA/WAS

INVERTER
SYSTEM INSIDE

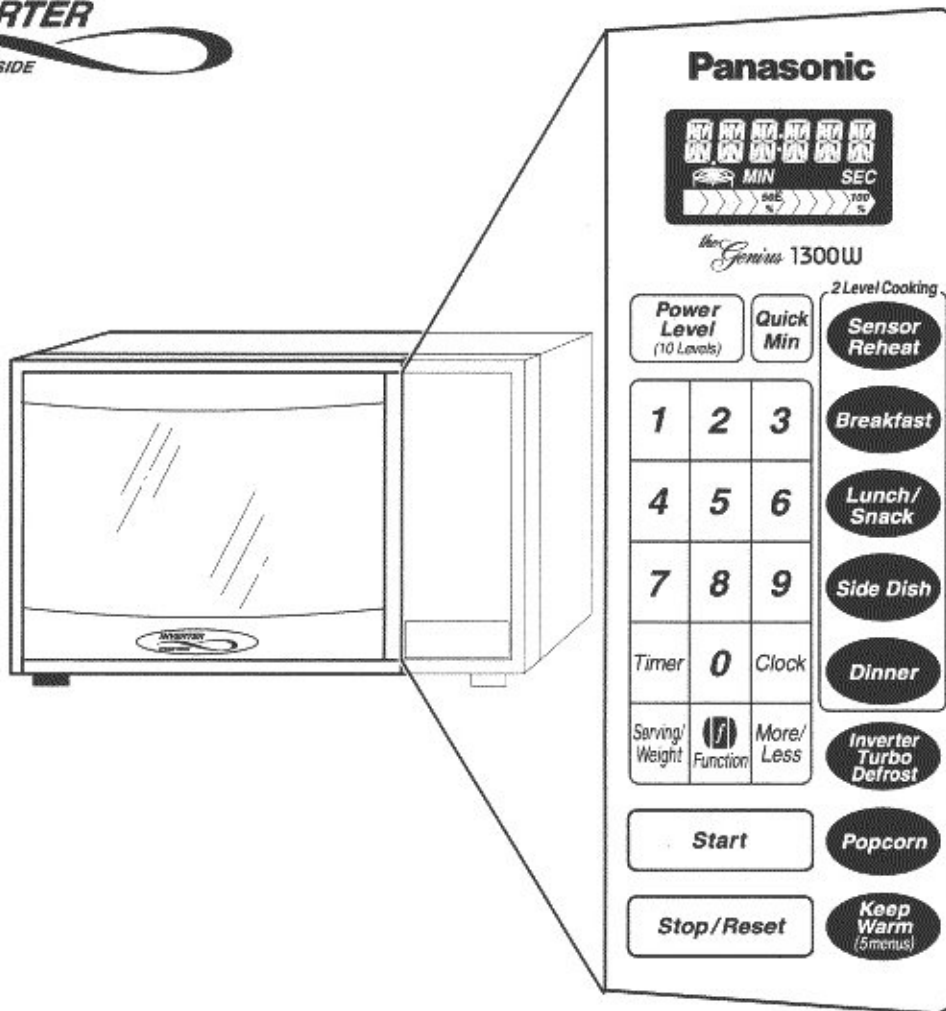

FOR ASSISTANCE:

Please call 1-800-211-PANA(7262)

-E-MAIL TO:

consumerproducts@panasonic.com

-REFER TO:

<http://www.Panasonic.com>

This manual contains Safety Instructions, Operating Instructions and Maintenance of the oven.

For Cooking Guide and Parts Information, see page 6.

Before operating this oven, please read these instructions completely.

Panasonic Consumer Electronics
Company, Division of Matsushita
Electric Corporation of America
One Panasonic Way
Secaucus, New Jersey 07094

B00034W00AP
DK-0002-0
Printed in U.S.A.

Thank you for purchasing the Panasonic Microwave Oven.
Please read the instructions completely.
Let's Start to Use Your Oven!—page 9.

PRECAUTIONS TO AVOID POSSIBLE EXPOSURE TO EXCESSIVE MICROWAVE ENERGY

- (a) Do not attempt to operate this oven with the door open since open-door operation can result in harmful exposure to microwave energy. It is important not to defeat or tamper with the safety interlocks.
- (b) Do not place any object between the oven front face and the door or allow soil or cleaner residue to accumulate on sealing surfaces.
- (c) Do not operate the oven if it is damaged. It is particularly important that the oven door close properly and that there is no damage to the:
 - (1) door (bent),
 - (2) hinges and latches (broken or loosened),
 - (3) door seals and sealing surfaces.
- (d) The oven should not be adjusted or repaired by anyone except properly qualified service personnel.

STAPLE YOUR STORE RECEIPT HERE.

If you have any questions or it seems there is a problem with the oven, contact **PANASONIC / QUASAR / TECHNICS Customer Call Center** for assistance, 1-800-211-PANA(7262) {9 a.m. - 9 p.m., E.S.T., toll free}.

The serial number of this product may be found on the right side of the oven door opening. You should note the model number and the serial number of this oven in the space provided and retain this book as a permanent record of your purchase for future reference.

Model No. _____

Serial No. _____

Date of Purchase _____

TABLE OF CONTENTS

Before Operating

Precautions	Inside Front Cover
Important Safety Instructions	2
Installation Instructions and Grounding Instructions	3
Safety Precautions	4
Cookware and Utensil Guide	5
Feature Diagram	7
Control Panel	7

Operation

Function Pad	8
Let's Start to Use Your Oven!	9
Setting the Clock	9
Quick Min	9
Keep Warm	9
Power & Time Setting	10
Using the Timer	10
Popcorn	11
Inverter Turbo Defrost & Conversion Chart	11
Sensor Reheat	12
Sensor Cook Pad	12
Two Level Cooking	15 - 16
Recipes	17 - 19

Cooking Tips

Defrosting Tips & Techniques	13
Microwave Shortcuts	14
Sensor Cooking Chart	15-16
Food Characteristics	20
Cooking Techniques	20 - 21

Maintenance

Care of Your Microwave Oven	6
Before Requesting Service	22
Warranty	23
Technical Specifications	Bottom of this page
Quick Guide to Operation	24

Technical Specifications

	NN-S780
Power source:	120V, 60 Hz
Power consumption:	12.0 Amps 1,400 W
Output*:	1300 W
Outside Dimensions: (H x W x D)	11 ¹⁵ / ₁₆ " (H) X 21 ⁷ / ₈ " (W) X 19 ⁹ / ₁₆ " (D) 304mm (H) X 555mm (W) X 497mm (D)
Oven Capacity Dimensions: (H x W x D)	9" (H) x 16 ⁷ / ₁₆ " (W) X 18 ¹ / ₂ " (D) 228mm (H) x 418mm (W) X 470mm (D)
Operating Frequency:	2,450 MHz
Uncrated Weight (Approx.):	32 lbs (14.3 kg)

Specifications subject to change without notice.

*IEC 705-88 Test procedure

IMPORTANT SAFETY INSTRUCTIONS

Your microwave oven is a cooking device and you should use as much care as you use with a stove or any other cooking device. When using this electric appliance, basic safety precautions should be followed, including the following:

WARNING—To reduce the risk of burns, electric shock, fire, injury to persons or exposure to excessive microwave energy:

1. Read all instructions before using the appliance.
2. Read and follow the specific **“PRECAUTIONS TO AVOID POSSIBLE EXPOSURE TO EXCESSIVE MICROWAVE ENERGY,”** found on back of the front cover.
3. This appliance must be grounded. Connect only to properly grounded outlet. See **“GROUNDING INSTRUCTIONS”** found on page 3.
4. Install or locate this appliance only in accordance with the installation instructions found on page 3.
5. Do not cover or block any openings on this appliance.
6. Do not store or use this appliance outdoors. Do not use this product near water—for example, near a kitchen sink, in a wet basement, or near a swimming pool, and the like.
7. Use this appliance only for its intended use as described in this manual. **DO NOT** use corrosive chemicals, vapours, or non-food products in this appliance. This type of oven is specifically designed to heat or cook. It is not designed for industrial or laboratory use. The use of corrosive chemicals in heating or cleaning will damage the appliance and may result in radiation leaks.
8. When cleaning surfaces of door and oven that come together on closing the door, use only mild, non-abrasive soaps or detergents applied with a sponge or soft cloth.
9. Do not allow children to use this appliance, unless closely supervised by an adult.
10. Do not operate this appliance if it has a damaged cord or plug, if it is not working properly, or if it has been damaged or dropped.
11. Do not immerse cord or plug in water.
12. Keep cord away from heated surfaces.
13. Do not let cord hang over edge of a table or counter.
14. This appliance should be serviced only by qualified service personnel. Contact the nearest authorized servicer for examination, repair or adjustment.
15. Some products such as whole eggs, narrow neck bottles and sealed containers—for example, closed glass jars—may explode and should not be heated in this oven.
16. To reduce the risk of fire in the oven cavity:
 - (a) Do not overcook food. Carefully attend appliance if paper, plastic, or other combustible materials are placed inside the oven to facilitate cooking.
 - (b) Remove wire twist-ties from paper or plastic bags before placing bag in oven.

(c) If materials inside the oven should ignite, keep oven door closed, turn oven off, and disconnect the power cord, or shut off power at the fuse or circuit breaker panel.

(d) Do not use the cavity for storage purposes. Do not leave paper products, cooking utensils, or food in the cavity when not in use.

General Use

1. **DO NOT** tamper with or make any adjustments or repairs to door, control panel housing, safety interlock switches or any other part of the oven. **DO NOT** remove outer panel from oven. Repairs must be done only by a qualified service person.

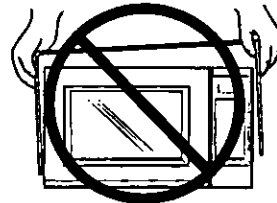

2. **DO NOT** operate the oven empty. The microwave energy will reflect continuously throughout the oven causing overheating, if food or water is not present to absorb energy. This could damage the oven and result in a risk of fire.

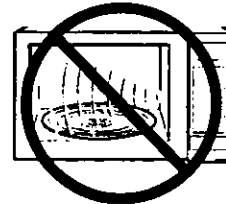

3. **DO NOT** dry clothes, newspapers or other materials in oven, or use newspapers or paper bags for cooking. Fire could result.
4. **DO NOT** use recycled paper products unless the paper product is labelled as safe for microwave oven use. Recycled paper products may contain impurities which may cause sparks, and result in fires when used.
5. **DO NOT** hit or strike control panel. Damage to controls may occur. Fire could result.
6. **POT HOLDERS** should always be used when removing items from the oven. Heat is transferred from the **HOT** food to the cooking container and from the cooking container to the Glass Tray. The Glass Tray can be very **HOT** after removing cooking container from oven.
7. **DO NOT** store flammable materials next to, on top of, or in the oven. These could be fire hazards.

SAVE THESE INSTRUCTIONS

For proper use of your oven read remaining safety cautions and operating instructions.

INSTALLATION & GROUNDING INSTRUCTIONS

Examine Your Oven

Unpack oven, remove all packing material and examine the oven for any damage such as dents, broken door latches or cracks in the door. Notify dealer immediately if oven is damaged. **DO NOT** install if oven is damaged.

Placement of Oven

- Oven must be placed on a flat, stable surface. For proper operation, the oven must have sufficient air flow. Allow 3-inches (7.6 cm) of space on both sides of the oven and 1-inch (2.5 cm) of space on top of oven.
 - DO NOT** block air vents. If they are blocked during operation, the oven may overheat. If the oven overheats, a thermal safety device will turn the oven off. The oven will remain inoperable. The oven should be taken to a Service Center.
 - DO NOT** place oven near a hot, damp surface such as a gas or electric range.
 - DO NOT** operate oven when room humidity is too high.
- This oven was manufactured for household use only.

Grounding Instructions

This appliance must be grounded. In the event of an electrical short circuit, grounding reduces the risk of electric shock by providing an escape wire for the electric current. This appliance is equipped with a cord having a grounding wire with a grounding plug. The plug must be plugged into an outlet that is properly installed and grounded.

WARNING—Improper use of the grounding plug can result in a risk of electric shock.

Consult a qualified electrician or service person if the grounding instructions are not completely understood or if doubt exists as to whether the appliance is properly grounded. If it is necessary to use an extension cord, use only a three wire extension cord that has a three blade grounding plug, and a three slot receptacle that will accept the plug on the appliance. The marked rating of the extension cord should be equal to or greater than the electrical rating of the appliance.

Power Supply

- A short power-supply cord is provided to reduce the risks resulting from becoming entangled in or tripping over a longer cord.
- Longer cord sets or extension cords are available and may be used if care is exercised in their use.
- If a long cord or extension cord is used, (a) the marked electrical rating of the cord set or extension cord should be at least as great as the electrical rating of the appliance, (b) the extension cord must be a grounding-type 3-wire cord, and (c) the longer cord should be arranged so that it will not drape over the counter top or tabletop where it can be pulled on by children or tripped over accidentally.

Wiring Requirements

- The oven must be on a **SEPARATE CIRCUIT**. No other appliance should share the circuit with the microwave oven. If it does, the branch circuit fuse may blow, the circuit breaker may trip, or the food may cook slower than the times recommended in this manual.
- The **VOLTAGE** used must be the same as specified on this microwave oven (120 V, 60 Hz). Using a higher voltage is dangerous and may result in a fire or other incident causing oven damage. Using a lower voltage will cause slow cooking. Panasonic is **NOT** responsible for damage resulting from the use of the oven with other than specified voltage.
- The oven must be plugged into at least a **20 AMP, 120 VOLT, 60 Hz GROUNDED OUTLET**. Where a standard two-prong outlet is encountered, it is the personal responsibility and obligation of the consumer to have it replaced with a properly grounded three-prong outlet.

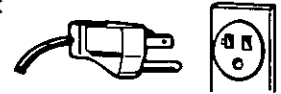

TV / Radio Interference

- Operation of the microwave oven may cause interference to your radio, TV or similar equipment.
- When there is interference, it may be reduced or eliminated by taking the following measures:
 - Clean door and sealing surfaces of the oven. (See Care of Your Microwave Oven)
 - Place the radio, TV, etc. away from the microwave oven as far as possible.
 - Use a properly installed antenna to obtain stronger signal reception.

Glass Tray

- DO NOT** operate the oven without Roller Ring and Glass Tray in place.
- DO NOT** operate the oven without the Glass Tray fully engaged on the drive hub. Improper cooking or damage to the oven could result. Verify that the Glass Tray is properly engaged and rotating by observing its rotation when you press **Start**.
- Only use Glass Tray specifically designed for this oven. Do not substitute any other glass tray.
- If Glass Tray is hot, allow to cool before cleaning or placing in water.
- DO NOT** cook directly on Glass Tray. Always place food in a microwave-safe dish, or on a rack set in a microwave-safe dish.
- If food or utensil on Glass Tray touches oven walls, causing the tray to stop moving, the tray will automatically rotate in opposite direction. This is normal.
- Glass Tray can turn in either direction.

Roller Ring

- Roller Ring and oven floor should be cleaned frequently to prevent excessive noise.
- Roller Ring must always be used for cooking along with Glass Tray.
- Always replace Roller Ring and Glass Tray in their proper positions.

Safety Precautions

Follow These Safety Precautions When Cooking in Your Oven

IMPORTANT

Proper cooking depends upon the power, the time set and the quantity of food. If you use a smaller portion than recommended and cook at the time for the recommended portion, fire could result.

1) HOME CANNING / DRYING FOODS / SMALL QUANTITIES OF FOODS

- **DO NOT** use your oven for home canning, your oven cannot maintain the food at the proper canning temperature. Improperly canned food may spoil and may be dangerous to consume.
- **DO NOT** dry meats, herbs, fruits or vegetables in your oven. Small quantities of food or foods with low moisture content can dry out, scorch or catch on fire if overheated.

2) POPCORN

Popcorn may be popped in a microwave oven corn popper. Microwave popcorn which pops in its own package is also available. Follow popcorn manufacturers' directions and use a brand suitable for the wattage of your microwave oven.

CAUTION:

When using pre-packaged microwave popcorn, follow recommended package instructions. Check package weight before using the *Popcorn* pad (see *Popcorn Pad* section). Set the oven for the weight of the popcorn package.

If these instructions are not followed, the popcorn may not pop adequately or may ignite and cause a fire. Never leave oven unattended when popping popcorn. Allow the popcorn bag to cool before opening, always open the bag away from your face and body to prevent steam burns.

3) DEEP FAT FRYING

- **DO NOT** attempt to deep fat fry in your microwave oven. Cooking oils may burst into flames and may cause damage to the oven and perhaps result in burns. Microwave utensils may not be able to withstand the temperature of the hot oil, and could shatter or melt.

4) FOODS WITH NONPOROUS SKINS

- Potatoes, apples, whole eggs, egg yolks, whole squash and sausages are examples of foods with nonporous skins. These types of foods must be pierced before microwave cooking to prevent their bursting.
- Use fresh potatoes for baking and cook until just done. Use recommended weights for programmed cooking. Overcooking causes dehydration and may result in a fire.

5) LIQUIDS

- Heated liquids can erupt if not mixed with air. **DO NOT** heat liquids in your microwave oven without first stirring. Overheated liquids will erupt.

6) GLASS TRAY / COOKING UTENSILS / FOIL

- Cooking utensils get hot during microwaving. Heat is transferred from the HOT food to the container and the Glass Tray. Use potholders when removing utensils from the oven or when removing lids or plastic wrap covers from cooking utensils to avoid burns.
- The Glass Tray will get hot during cooking. It should be allowed to cool before handling or before paper products, such as paper plates or microwave popcorn bags, are placed in the oven for microwave cooking.
- When using foil, skewers, warming rack or utensils made of metal in the oven, allow at least 1-inch (2.5 cm) of space between metal material and interior oven walls. If arcing occurs (sparking), remove metal material (skewers, etc.) and/or transfer to a non-metallic container.
- Dishes with metallic trim should **not** be used, as arcing may occur.
- If an entree is heated in a foil tray, maintain at least 1-inch (2.5 cm) spacing from the oven walls.

7) PAPER TOWELS / CLOTHS

- **DO NOT** use paper towels or cloths which contain a synthetic fiber woven into them. The synthetic fiber may cause the towel to ignite. Use paper toweling under supervision.

8) BROWNING DISHES / OVEN COOKING BAGS

- Browning dishes or grills are designed for microwave cooking only. Always follow instructions provided by the manufacturer.
DO NOT preheat browning dish more than 6 minutes.
- If an oven cooking bag is used for microwave cooking, prepare according to package directions. **DO NOT** use a wire twist-tie to close bag, instead use plastic ties, cotton string or a strip cut from the open end of the bag.

9) THERMOMETERS

- **DO NOT** use a conventional meat thermometer in your oven. Arcing may occur. Microwave-safe thermometers are available for both meat and candy.

10) BABY FORMULA / FOOD

- **DO NOT** heat baby formula or food in the microwave oven. The glass jar or surface of the food may appear to be only warm while the interior can be so hot as to burn the infant's mouth and esophagus.

11) REHEATING PASTRY PRODUCTS

- When reheating pastry products, check temperatures of any fillings before eating. Some foods have fillings which heat faster and can be extremely hot, while the surface remains warm to the touch (ex. Jelly Donuts).

12) GENERAL OVEN USAGE GUIDELINES

- **DO NOT** use the oven for any reason other than the preparation of food.
- **DO NOT** leave oven unattended while in use.

Cookware and Utensil Guide

ITEM	MICROWAVE	COMMENTS
Aluminum Foil	Yes, for Shielding only	Small strips of foil can be molded around thin parts of meat or poultry to prevent overcooking. Arcing can occur if foil is too close to oven wall or if too much foil is used.
Browning Dish	Yes	Browning dishes are designed for microwave cooking only. Check browning dish information for instructions and heating chart. Do not preheat for more than 6 minutes.
Brown paper bags	No	May cause a fire in the oven.
Dinnerware Labeled "Microwave-Safe"	Yes	Check manufacturers' use and care directions for use in microwave heating. Some dinnerware may state on the back of the dish, "Oven-Microwave Safe".
Other Dinnerware	?	Use CONTAINER TEST below.
Disposable polyester Paperboard Dishes	Yes	Some frozen foods are packaged in these dishes. Can be purchased in grocery stores.
Fast Food Carton with Metal Handle	No	Metal handle may cause arcing.
Frozen Dinner Tray Metal	Yes	Frozen dinners may be heated in foil tray, if tray is less than 3/4-inch (2 cm) high. Place foil tray in center of oven. Leave at least 1-inch (2.5 cm) space between foil tray and oven walls. Heat only 1 foil tray in the oven at a time.
Microwave-safe	Yes	For containers more than 3/4-inch (2 cm) deep, remove food and place in a similar size microwave-safe container.
Glass Jars	Yes, use caution	Remove lid. Heat food until just warm, not HOT. Most glass jars are not heat resistant. Do not use for cooking.
Glassware Heat Resistant Oven Glassware & Ceramics	Yes	Ideal for microwave cooking and browning. (See CONTAINER TEST below).
Metal Bakeware	No	Not recommended for use in microwave ovens.
Metal Twist-Ties	No	May cause arcing which could cause a fire in the oven.
Oven Cooking Bag	Yes	Follow manufacturers' directions. Close bag with the nylon tie provided, a strip cut from the end of the bag or a piece of cotton string. Do not close with metal twist-tie. Make six 1/2-inch (1 cm) slits near the closure.
Paper Plates & Cups	Yes	Use to warm cooked foods and to cook foods that require short cooking times such as hot dogs.
Paper Towels & Napkins	Yes	Use to warm rolls and sandwiches by microwave.
Parchment Paper	Yes	Use as a cover to prevent spattering. Safe for use in microwave, microwave/convection and conventional ovens.
Plastic Microwave-Safe Cookware	Yes	Should be labeled, "Suitable for Microwave Heating." Check manufacturers' directions for recommended uses.
Reheat & Storage	Yes, use caution	Some microwave-safe plastic dishes are not suitable for cooking foods with high fat or sugar content. The heat from hot food may cause the plastic to warp.
Melamine	No	This material absorbs microwave energy. Dishes get HOT!
Plastic Foam Cups	Yes	Plastic foam will melt if foods reach a high temperature. Use to bring foods to a low serving temperature.
Plastic Wrap	Yes	Use to cover food during cooking to retain moisture and prevent spattering. Should be labeled "Suitable for Microwave Heating". Check package directions.
Straw, Wicker, Wood	Yes	Use only for short term reheating and to bring food to a low serving temperature
Thermometers Microwave-safe, only	Yes	Use only microwave-safe meat and candy thermometers.
Conventional	No	Not suitable for use in microwave oven, will cause sparks and get hot.
Wax paper	Yes	Use as a cover to prevent spattering and to retain moisture.

CONTAINER TEST

TO TEST A CONTAINER FOR SAFE MICROWAVE OVEN USE: Fill a 1-cup glass measure with water and place it in the microwave oven along with the container to be tested; **heat one (1) minute at P10 (HIGH)**. If the container is microwave oven-safe (transparent to microwave energy), the container should remain comfortably cool and the water should be hot. If the container is hot, it has absorbed some microwave energy and should NOT be used. This test cannot be used for plastic containers.

Care of Your Microwave Oven

BEFORE CLEANING:

Unplug at socket of the oven. If impossible, leave oven door open to prevent oven from accidentally turning on.

AFTER CLEANING:

Be sure to replace the Roller Ring and Glass Tray in the proper position and press **Stop/Reset** Pad to clear the screen.

Inside of the oven:

Wipe with a damp cloth. Mild detergent may be used if the oven gets very dirty. The use of harsh detergents or abrasives is not recommended.

Glass Tray:

Remove and wash in warm, soapy water or in a dishwasher.

Outside oven surfaces.

Clean with a damp cloth. To prevent damage to the operating parts inside the oven, water should not be allowed to seep into ventilation openings.

2 Level Cooking Rack:

Wash in mild, soapy water.



Oven Door:

* Wipe with a soft cloth when steam accumulates inside or around the outside of the oven door. During cooking, especially under high humidity conditions, steam is given off from food. (Some steam will condense on cooler surfaces, such as the oven door. This is normal.)

* Inside surface is covered with a heat and vapor barrier film. Do not remove.

Menu Label:

Do not remove. Wipe with damp cloth.

Control Panel:

* Covered with a removable protective film to prevent scratches during shipping. Small bubbles may appear under this film. (Hint - To remove film, apply masking or clear tape to an exposed corner and pull gently.)

* If the control panel becomes wet, clean it with a soft dry cloth. Do not use harsh detergents or abrasives on the Control Panel.

Roller Ring and oven cavity floor:

Wipe the bottom surface of the oven with mild detergent water or window cleaner and dry. Roller Ring may be washed in mild soapy water or dishwasher. These areas should be kept clean to avoid excessive noise.

NOTES

For more information regarding microwave cooking, order our new **COOKING GUIDE** (68 pages of recipes & charts).

DESCRIPTION	PART NUMBER	PRICE
Instruction/Operating Manual (this book)	B00034W00AP	①
COOKING GUIDE	B000B8250AP	①
Glass Tray (see Care of Your Microwave Oven above)	B06014W00AP	①
Roller Ring Assembly	B290D4M00AP	①
2 Level Cooking Rack	B060X4P00AP	①

For pricing quotes, call or write the Parts & Literature Department at the phone or address listed below. Please have your credit card information readily available.

Shipping & handling are not included. Price & availability subject to change. Sorry, no COD's.

PANASONIC SERVICES COMPANY

20421 84th Avenue South

(800) 833-9626 - Phone

Kent, WA 98032

(800) 237-9080 - FAX

Feature Diagram

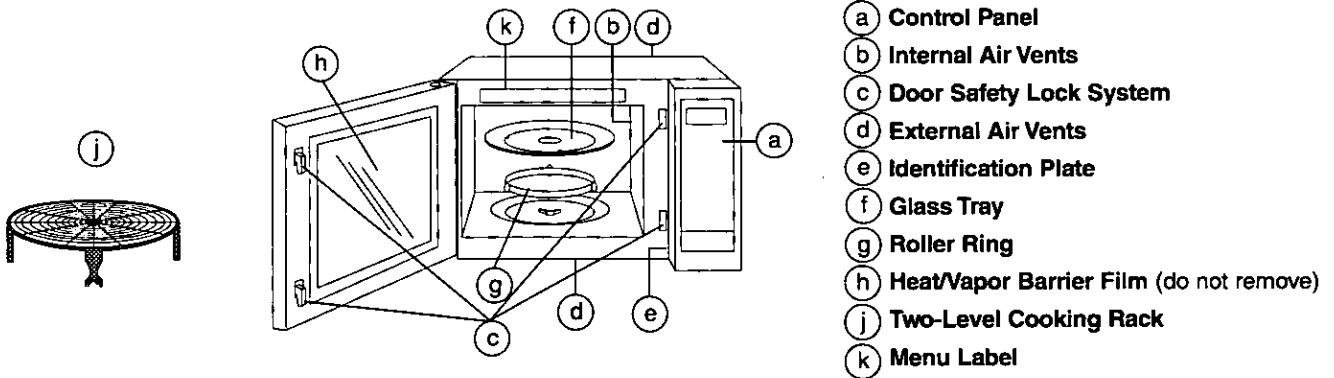

- (a) Control Panel
- (b) Internal Air Vents
- (c) Door Safety Lock System
- (d) External Air Vents
- (e) Identification Plate
- (f) Glass Tray
- (g) Roller Ring
- (h) Heat/Vapor Barrier Film (do not remove)
- (i) Two-Level Cooking Rack
- (k) Menu Label

Control Panel

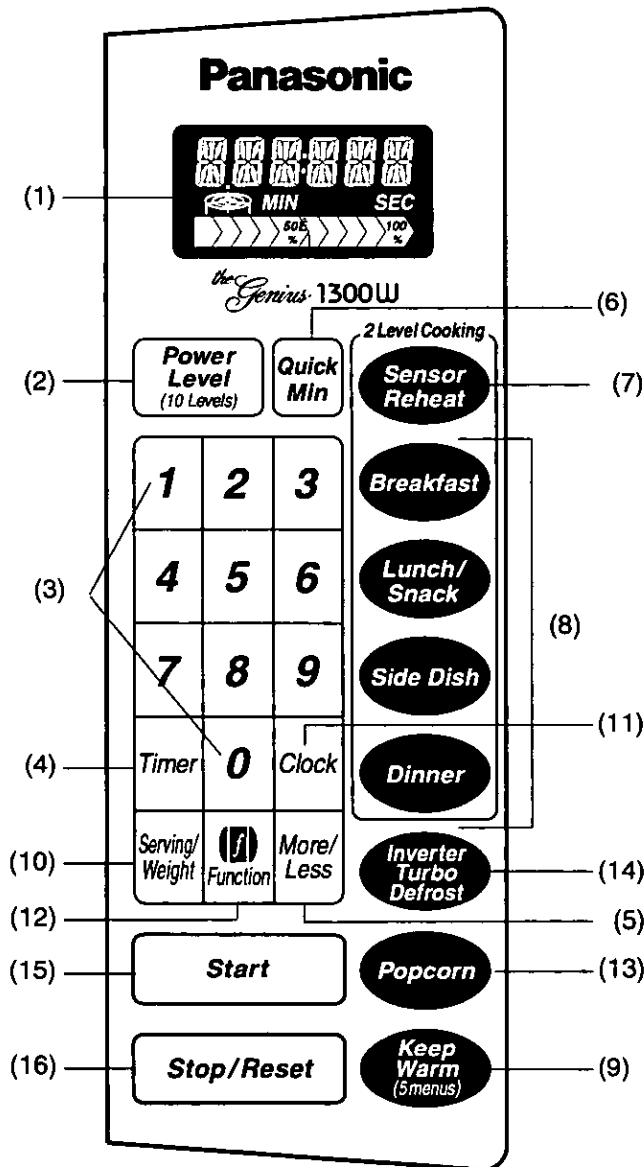

- (1) **Display Window**
Step by step instructions scroll for easy operation.
 - (2) **Power Level Pad** (page 10)
 - (3) **Number Pads**
 - (4) **Timer Pad** (page 10)
 - (5) **More/Less Pad** (page 12)
 - (6) **Quick Min Pad** (page 9)
 - (7) **Sensor Reheat Pad** (page 12)
 - (8) **Sensor Cook Pad** (page 12)
 - (9) **Keep Warm Pad** (page 9)
 - (10) **Serving/Weight Pad** (page 9)
 - (11) **Clock Pad** (page 9)
 - (12) **Function Pad** (page 8)
 - (13) **Popcorn Pad** (page 11)
 - (14) **Inverter Turbo Defrost Pad** (page 11)
 - (15) **Start Pad**
One tap allows oven to begin functioning. If door is opened or **Stop/Reset** Pad is pressed once during oven operation, **Start** Pad must be pressed again to restart oven.
 - (16) **Stop/Reset Pad**
Before cooking: One tap clears your instruction.
During cooking: One tap temporarily stops the cooking process. Another tap cancels all your instructions and time of day or colon appears on the **Display Window**.
- Beep Sound:**
When a pad is pressed correctly, a beep will be heard. If a pad is pressed and no beep is heard, the unit did not, or cannot, accept the instruction. The oven will beep twice between programmed stages. At the end of any complete program, the oven will beep 5 times.

To Use Function Pad

This unique feature of your PANASONIC microwave oven allows you to establish the initial non-cooking features of your oven such as CHILD LOCK, WORD SPEED, LANGUAGE CHOICE (ENGLISH, FRENCH OR SPANISH), plus many more. See below.

1)		Press: FUNCTION. Menu Action Message is "Select Function 0 through 9, 1--LANGUAGE CHOICE --- etc".
2)	Select a number (0-9) Ex. CHILD LOCK is 5	Press 5: Menu Action Message is "CHILD LOCK ON/OFF".
3)	Select <input type="text" value="1"/> , <input type="text" value="2"/> or <input type="text" value="3"/>	Press: One number. Your selection is now part of the operating system. You can change it any time.
4)	Continue until you have completed your selections.	See below for other options.

	1	LANGUAGE CHOICE The oven has English, French and Spanish display. The display appears in English when you plug-in. 1 ENGLISH → Display appears in English. 2 FRANCAIS → Display appears in French. 3 ESPANOL → Display appears in Spanish.
	2	Lb/KG CHOICE The oven has both imperial and metric weight measurements. The oven displays the weight in imperial when you plug it in. 1 Lb → Weight can be set in oz/lb, (Imperial). 2 KG → Weight can be set in g/kg, (Metric).
	3	WORD SPEED The speed of word scrolling in the <i>Display Window</i> can be sped up or slowed down. 1 QUICK → Words scroll quickly. 2 MEDIUM → Scrolling speed returns to initial setting. 3 SLOW → Words scroll slowly.
	4	MENU ACTION ON/OFF MENU ACTION SCREEN helps you to program your oven by prompting the next step to be taken. When you become familiar with your oven, the prompting can be turned off. 1 ON → Prompting Guide will appear. 2 OFF → Prompting Guide will not appear.
	5	CHILD LOCK ON/OFF The oven has Child Safety Lock feature which prevents use by children. It does not lock the door. 1 ON → Child Lock has been set and operation will not be accepted. 2 OFF → Child Lock has been cancelled.
	6	BEEP ON/OFF If you wish to have the oven operate with no beep, it can be eliminated. 1 ON → Beep sound will reactivate. 2 OFF → Beep sound will not be heard.
	7	REMINDER BEEP ON/OFF A reminder beep works to remind you to remove the food from the oven after the completion of cooking. It will occur every 15 seconds. 1 ON → Reminder beep will work. 2 OFF → Reminder beep will not work.
	8	DAYLIGHT SAVING ON/OFF 1 ON → Time of day will advance one hour. 2 OFF → Time of day returns to original setting.
	9	CLOCK ON/OFF Clock display can be turned off. 1 ON → Clock display will appear in the <i>Display Window</i> . 2 OFF → Clock display will not appear in the <i>Display Window</i> . Time of day will not be lost while the display is off.
	0	DEMO MODE ON/OFF Demo mode is designed for retail store display. In this mode, the oven can be demonstrated with no power in the oven. 1 ON → The oven is in Demo mode. 2 OFF → The oven is not in Demo mode.

Let's Start to Use Your Oven!

1. Plug into a properly grounded electrical outlet.



20 AMP
OUTLET

Display Window

"WELCOME TO PANASONIC - - REFER TO OPERATING INSTRUCTIONS BEFORE USE" scrolls across *Display Window*.



2. The messages in the *Display Window* automatically appear in English.

If you wish to use Spanish or French, use the **Function** pad language option.

If you wish to use metric measurements, use the **Function** pad weight option.

Display Window

3. At the end of the "WELCOME . . ." message, a colon appears in the *Display Window*.

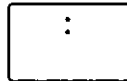

Now, enjoy cooking with your Panasonic microwave.

Quick Min

This feature allows you to set and/or add cooking times easily in multiples of one minute.

To Set Cooking Time:

Example: 5 minutes

1. **Quick Min** Press. (up to 10)

Set cooking time. Power level is P10 (HIGH).

Display Window



2. **Start** Press.

Cooking begins and time counts down. Power level arrow begins to scroll.



At the end of cooking, five beeps sound and "ENJOY YOUR MEAL" appears in the *Display Window*



NOTES:

1. To use with other power levels, Press **Power Level**, then **Quick Min**.
2. If you use **Quick Min**, you can not use the Number Pads or vice versa.
3. Press **Quick Min** to add more time during cooking. To verify the additional cooking time, check the *Display Window*.

Clock

This feature allows you to display the time of day. The oven will operate without setting the clock.

Example: To set 12:34 AM or PM.

1. **Clock** Press.

Colon appears and flashes.

Display Window

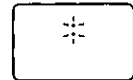

Press.

"SET TIME" scrolls across *Display Window*.

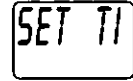

2. Enter time of day using number pads.



Enter time of day using number pads.

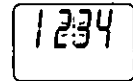

Colon continues flashing.

"PRESS CLOCK PAD" scrolls across *Display Window*.

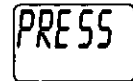

3. **Clock** Press **Clock** again to set time of day.

Press **Clock** again to set time of day.

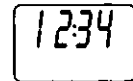

Colon stops flashing.

NOTES:

1. To reset the clock, repeat step 1 through 3.
2. The Clock will retain the time of day as long as electricity is supplied.
3. Clock is a 12 hour display.
4. Oven will not operate while colon is flashing.

Keep Warm Pad

This feature helps you to keep a certain selection of foods warm for 30 minutes after cooking. (Pie, Gravy, Stew, Casserole or Mashed Potatoes)

1. **Keep Warm** Press twice.

"GRAVY - - PRESS SERV/WEIGHT" appears in *Display Window*.

Display Window



2. **Serving Weight** Press twice.

Verify serving size (1-4) in *Display Window*.



3. **Start** Press.

Keep Warm time appears in *Display Window* and begins to count down from 30 minutes.



At the end of cooking, five beeps sound and "ENJOY YOUR MEAL" appears in the *Display Window*.







Manual Operation (Power & Time Setting)



This feature allows you to manually set the power and time for microwave cooking.

Press **Power Level** pad until desired power appears in the **Display Window**. See Chart below.

Example: To cook at P5 for 1 minute 30 seconds.

1.  "P 5 SET TIME" appears in **Display Window**.
Press six times. 

2.  Enter cooking time using number pads. 

3.  **Display Window** counts down and power level arrow begins to scroll. 

At the end of cooking, five beeps sound and "ENJOY YOUR MEAL" appears in the **Display Window**

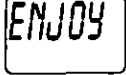

Press Power Level	Power Level	Display Window
once	P10 (HIGH)	
twice	P 9	
3 times	P 8	
4 times	P 7 (MED. HIGH)	
5 times	P 6 (MEDIUM)	
6 times	P 5	
7 times	P 4	
8 times	P 3 (MED. LOW)	
9 times	P 2	
10 times	P 1 (LOW)	

NOTES:

- For more than one stage cooking, repeat steps 1 & 2 for each stage of cooking before pressing **Start** pad. Maximum number of stages for cooking is 5 stages.
- When selecting P10(HIGH) power for the first stage, you can begin at step 2.
- Two beeps will sound between each stage of programming. Five beeps will sound at the end of the entire sequence.
- When selecting P10(HIGH) power, the maximum time is 30 minutes. For other power levels the maximum time is 99 minutes and 99 seconds.
- For reheating, use P10(HIGH) for liquids, P 7(MEDIUM-HIGH) for most foods and P 6 (MEDIUM) for dense foods.
- For defrosting, use P 3(MEDIUM-LOW/DEF).



Timer

This feature allows you to:

- Use it as a Kitchen **TIMER**.
- Program **STAND** time after cooking is completed.
- Program **DELAY** time for beginning cooking.

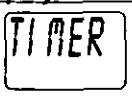
To Set **TIMER**:

1.  "TIMER - - SET TIME" appears in the **Display Window**.
Press once. 

2.  Enter time using Number pads (up to 99 minutes and 99 seconds). 

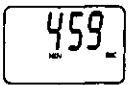
3.  **Timer** will count down. No cooking will occur.
Press once. 

To Activate **TIMER** Program:

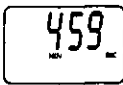
3.  **Timer** will count down. No cooking will occur.
Press once. 

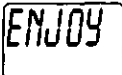

At the end of cooking, five beeps sound and "ENJOY YOUR MEAL" appears in the **Display Window**



NOTES:

- When each stage finishes, a two beep signal sounds. At the end of the program, the oven will beep five times.
- If oven door is opened during the **TIMER**/**DELAY**/**STAND** time, the time in the **Display Window** will continue to count down.
- DELAY** time cannot be programmed before any Auto Control Feature. This is to prevent the starting temperature of the food from rising before defrosting or cooking begins. A change in the starting temperature would cause inaccurate cooking results.
- Timer can be set up to 99 minutes and 99 seconds.



To Set **DELAY** Time:

 →  → (Input up to 4-stage Cooking Program.) → 

Press once. Enter **DELAY** time using number pads. Press.

* Cooking will start after **DELAY** time has expired.

To Set **STAND** Time:

(Input up to 4-stage Cooking Program.) →  →  → 

Press once. Enter **STAND** time using number pads. Press.



* **STAND** time will count down after cooking occurs.

Popcorn Pad

For use with prepackaged Popcorn bags.



Example: To pop 3.5 oz. package of microwave popcorn.

Press **Popcorn** pad until package weight appears in the **Display Window**. See Chart below.

1.  "POPCORN (weight) - - PRESS START" scrolls across **Display Window**. 

Press five times.

Verify packaged weight in **Display Window**. 

2.  Cooking begins. 

Press.

Time counts down and power level arrow scrolls. 

At the end of cooking, five beeps sound and "ENJOY YOUR MEAL" appears in the **Display Window**

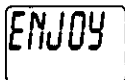

Press Popcorn pad	Popcorn package	Time
once	1.75 oz (50 g)	will vary depending on size and wattage of oven
twice	2.65 oz (75 g)	
three times	2.85 oz (80 g)	
four times	3.0 oz (90 g)	
five times	3.5 oz (99 g)	

NOTES:

1. Popcorn packages should be at room temperature.
2. Place bag in oven according to manufacturer's directions.
3. Pop **one** bag at a time.
4. After popping, allow bag to cool. Carefully open bag away from face and body, since popcorn and steam are extremely hot.
5. **NEVER** leave the oven unattended when popping popcorn.
6. Do not reheat unpopped kernels or reuse bag.
7. With the many varieties of microwave popcorn available in the market place, it may be necessary for you to move the popcorn container to the outer edge of the glass tray to obtain the best cooking results.

REMARKS: When popping multiple bags one right after the other, the cooking times may vary slightly. This does not affect the popping results.

CAUTION: If prepackaged popcorn is of a different weight than the recommended weight, do not use the preset popcorn settings. Set Power Level and Time according to the manufacturer's instructions.

Inverter Turbo Defrost



This feature allows you to defrost meat, poultry and seafood simply by entering the weight.

Example: To defrost 2.5 lbs (2 lbs 8 oz) of meat.

1.  "INVERTER TURBO DEFROST - - SET WEIGHT" appears in **Display Window** 

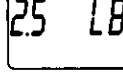
Press.

2.  Enter weight using number pads. (6.0 lb maximum) 

3.  Defrost time* appears. 

Press.

Display Window counts down. 

At the end of cooking, five beeps sound and "ENJOY YOUR MEAL" appears in the **Display Window**.



***NOTE:** Time will vary depending on size and wattage of your oven.

Conversion Chart

Follow this chart to convert ounces or hundredths of a pound into tenths of a pound.

Example: If a piece of frozen meat weighs 1 pound 14 ounces, the equivalent is 1.9 pounds.



Ounces	Hundredths of a Pound	Tenths of a Pound
0	.96 - .05	0.0
1 - 2	.06 - .15	0.1
3 - 4	.16 - .25	0.2
5	.26 - .35	0.3
6 - 7	.36 - .45	0.4
8	.46 - .55	0.5
9 - 10	.56 - .65	0.6
11 - 12	.66 - .75	0.7
13	.76 - .85	0.8
14 - 15	.86 - .95	0.9

Sensor Cook

This sensor feature allows you to cook any quantity of food with only one touch. The oven does it all for you.

- 

Press. "BREAKFAST -- SELECT SERVING/WEIGHT" appears in *Display Window*.

 - 

Optional*.
 - 

Press. Cooking starts. The word "SENSOR" appears in the *Display Window*.

 - After heat/steam is detected by the *Genius*, 2 beeps sound.

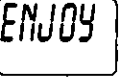

The remaining cooking time appears in the *Display Window* and begins to count down. Power level arrow scrolls.

- At the end of cooking, five beeps sound and "ENJOY YOUR MEAL" appears in the *Display Window*.
- 

*More/Less Pad

Preferences for food doneness vary with each individual. After having used the Sensor Cooking a few times, you may decide you would prefer your food cooked to a different doneness. By using the *More/Less* pad, the programs can be adjusted to cook food for a longer or shorter time.

- 1 tap=*More* cooking
- 2 taps=*Less* cooking
- 3 taps=original setting

Press *More/Less* before pressing *Start*.

For best Sensor cooking results, follow these recommendations.

BEFORE Reheating/Cooking



- The room temperature surrounding the oven should be below 95° F (35° C).
- Food weight should exceed 4 oz. (110 g).
- Glass Tray and outside of container should be dry.
- Cover food loosely but completely with plastic wrap, or place foods in a casserole dish with a proper fitting lid.
- All foods should be taken from their normal storage place.

Sensor Reheat

This feature allows you to reheat any quantity of food with only one touch.

- 

Press. "SENSOR REHEAT -- PRESS START" appears in *Display Window*.

 - 

Optional.*
 - 

Optional.
 - 



Press. Reheating starts. The word "SENSOR" appears in the *Display Window*.



After heat/steam is detected by the *Genius*, 2 beeps sound.



The remaining cooking time appears in the *Display Window* and begins to count down. Power level arrow scrolls.

- At the end of cooking, five beeps sound and "ENJOY YOUR MEAL" appears in the *Display Window*.
- 

NOTES:

Casseroles - Add 3 to 4 tablespoons of liquid; cover with lid or plastic wrap. Stir when time appears in the *Display Window*.

Canned foods - Empty contents into casserole dish or serving bowl; cover dish with lid or plastic wrap. After reheating, release plastic wrap and stand.

Plate of food - Arrange food on plate; top with butter, gravy, etc.. After reheating, release plastic wrap and stand.

Follow the recommendations for Sensor Cooking, in addition to the following:

DO NOT:

- Reheat bread and pastry products. Use manual power and time for these foods.
- Reheat raw or uncooked food.
- Use if oven cavity is warm.
- Use for beverages.
- Use for frozen foods.

DURING Reheating/Cooking:

DO NOT open the oven door until 2 beeps sound and time appears in the *Display Window*. Doing so will cause inaccurate cooking since the steam from food is no longer contained within the oven cavity. Once the timer begins to count down, the oven door may be opened to stir, turn, shield, rearrange, mix or add foods.

AFTER Reheating/Cooking:

All foods should have a covered stand time.

Defrosting Tips & Techniques

Before Freezing:

1. Freeze meats, poultry and fish in packages with only 1 or 2 layers of food.
Place wax paper between layers.
2. Package in heavy-duty plastic wraps, bags (labeled "For Freezer") or freezer paper.
3. Remove as much air as possible, i.e. create a vacuum.
4. Seal securely, date and label.

To Defrost:

1. Remove wrapper. This helps moisture to evaporate.
Juices from food can get hot and cook the food.
2. Set food on microwave safe roasting rack in an appropriately sized dish.
3. Place roasts fat-side down. Place whole poultry breast-side down.
4. Drain liquids during defrosting.
5. Turn over (invert) items during defrosting.
6. Shield edges and ends if needed. (See **Cooking Techniques**).
7. Select power and minimum time so that items will be under-defrosted.

After Defrosting:

1. Large items may be icy in the center. Defrosting will complete during **STANDING TIME**.
2. Let stand, covered with plastic wrap, in the refrigerator for time shown in the chart below.
3. See chart below for standing time and rinsing directions.
4. Items which have been layered should be rinsed separately or have a longer stand time.

FOOD	DEFROST TIME (min. per pound) (P 3)	DURING DEFROSTING	AFTER DEFROSTING	
			Stand Time	Rinse (cold water)
Fish and Seafood [up to 3 lbs. (1.4 kg)]				
Crabmeat	6	Break apart/Rearrange	5 min.	YES
Fish Steaks	4 to 6	Turn over		
Fish Fillets	4 to 6	Turn over/Rearrange/Shield ends		
Sea Scallops	4 to 6	Break apart/Remove defrosted pieces		
Whole fish	4 to 6	Turn over		
Meat				
Ground Meat	4 to 5	Turn over/Remove defrosted portion/Shield edges	10 min.	NO
Roasts [2½ - 4 lbs. (1.1-1.8 kg)]	4 to 8	Turn over/Shield ends and defrosted surface	30 min. in refrig	
Chops/Steak	6 to 8	Turn over/Rearrange/Shield ends and defrosted surface	5 min.	
Ribs/T-bone	6 to 8	Turn over/Rearrange/Shield ends and defrosted surface		
Stew Meat	4 to 8	Break apart/Rearrange/Remove defrosted pieces		
Liver (thin sliced)	4 to 6	Drain liquid/Turn over/Separate pieces	---	
Bacon (sliced)	4	Turn over	---	
Poultry				
Chicken, Whole [up to 3 lbs. (1.4 kg)]	4 to 6	Turn over/Shield	20 min. in refrig.	YES
Cutlets	4 to 6	Break apart/Turn over/Remove defrosted pieces	5 min.	
Pieces	4 to 6	Break apart/Turn over/Shield	10 min.	
Cornish Hens	6 to 8	Turn over/Shield		
Turkey Breast [5 - 6 lbs. (2.3 - 2.7 kg)]	6	Turn over/Shield	20 min. in refrig	

Microwave Shortcuts

FOOD	POWER SETTING	TIME (in minutes)	DIRECTIONS
To separate Bacon , 1 pound (450 g)	P10 (HIGH)	30 sec.	Remove wrapper and place in a microwave safe dish. After heating, use a plastic spatula to separate slices.
To soften Brown Sugar 1 cup (250 mL)	P10 (HIGH)	20 - 30 sec.	Place brown sugar in microwave safe dish with a slice of bread. Cover with plastic wrap.
To melt Butter , 1 stick, ¼ pound (110 g)	P 6 (MEDIUM)	1½ - 2	Remove wrapper and place butter in a microwave safe dish covered with plastic wrap.
To soften Butter , 1 stick ¼ pound (110 g)	P 3 (MEDIUM-LOW)	1	Remove wrapper and place butter in a microwave safe dish.
To melt Chocolate , 1 square, 1 oz. (28 g)	P10 (HIGH)	1 - 1½	Remove wrapper and place chocolate in a microwave safe dish. Stir before adding more time. (Stir until completely melted.) <i>Note: Chocolate holds its shape even when softened.</i>
To melt Chocolate , ½ cup (125 mL) chips	P10 (HIGH)	1 - 1½	
To toast Coconut , ½ cup (125 mL)	P10 (HIGH)	1	Place in a microwave safe dish. Stir every 30 seconds.
To soften Cream Cheese , 8 oz. (250 g)	P 3 (MEDIUM-LOW)	1 - 2	Remove wrapper and place in a microwave safe bowl.
To brown Ground Beef , 1 pound (450 g)	P10 (HIGH)	4 - 5	Crumble into a microwave safe colander set into another dish. Stir twice. Drain grease.
To steam Hand Towels - 4	P10 (HIGH)	20 - 30 sec.	Soak in water, then wring out excess. Place on a microwave safe dish. Heat. Present immediately.
To soften Ice Cream , ½ gallon (2 qt.)	P 3 (MEDIUM-LOW)	1 - 1½	Check often to prevent melting.
Cup of liquid boiling water, broth, etc. 1 cup, 8 oz. (250 mL) 2 cups, 16 oz. (500 mL) to heat milk 1 cup, 8 oz. (250 mL) 2 cups, 16 oz. (500 mL)	P10 (HIGH) P 7 (MEDIUM-HIGH)	2½ - 3 4 2 - 3 4 - 5	Heated liquids can erupt if not stirred. Do not heat liquids in your microwave oven without stirring before and after heating.
To roast Nuts , 1½ cups (375 mL)	P10 (HIGH)	4 - 5	Spread nuts into a 9-inch (230 mm) microwave safe pie plate. Stir occasionally.
To toast Sesame Seeds , ¼ cup (50 mL)	P10 (HIGH)	3 - 5	Place in a small microwave safe bowl. Stir twice.
To skin Tomatoes (one at a time)	P10 (HIGH)	30 sec.	Place tomato into a microwave safe bowl containing boiling water. Rinse and peel. Repeat for each tomato.
To remove Cooking Odors	P10 (HIGH)	5	Combine 1 to 1½ cups (250 - 375 mL) water with the juice and peel of one lemon in a small microwave safe bowl. After heating, wipe interior of oven with damp cloth.

Sensor Cook Chart

Ⓛ Indicates 2 Level Cooking

Pad	Recipe	Serving/Weight	HINTS
Breakfast	1. Breakfast Sausage Ⓛ Oatmeal	4 each / 1/2 cup	Follow manufacturers' directions for preparation of pre-cooked breakfast sausage. Arrange sausage in a radial pattern. Place on top of 2 Level Cooking Rack. Oatmeal place inside microwave-safe serving bowl with no cover. Follow manufacturers' directions for preparation of quick oatmeal. Place on top of Glass Tray.
	2. Omelet/Bacon Ⓛ	2 eggs / 2 slices	Follow Basic Omelet recipe for 2 eggs on Page 17. Place on top of 2 Level Cooking Rack. Place bacon on microwave-safe dish covered with paper towel. Place on top of Glass Tray. Dishes should be shifted in the oven to ensure even cooking. Times may vary by brand (weight).
	3. Bacon/Oatmeal Ⓛ	2 slices / 1/2 cup	Place oatmeal inside a microwave-safe serving bowl with no cover. Follow manufacturers' directions for preparation of quick oatmeal. Place on top of 2 Level Cooking Rack. Place bacon on microwave-safe dish covered with paper towel. Place on top of Glass Tray. Dishes should be shifted in the oven to ensure even cooking. Times may vary by brand (weight).
	4. Breakfast Sausage	8 maximum	Follow manufacturers' directions for preparation of pre-cooked breakfast sausage. Place in a radial pattern. For 2 Level Cooking, dishes should be shifted in the oven to ensure even cooking.
	5. Breakfast Sausage Ⓛ	8 X 2 maximum	
	6. Oatmeal	1/2 cup, 1 cup	Place inside microwave-safe serving bowl with no cover. Follow manufacturers' directions for preparation of quick oatmeal.
Lunch/Snack	1. Frozen Entrées/ Soup Ⓛ	8 oz. / 1 cup	Place 1 cup of soup in a microwave-safe serving bowl. Cover loosely with vented plastic wrap. Place on top of 2 Level Cooking Rack. For Frozen Entrées, follow manufacturers' directions for covering or removing covers. Place on top of Glass Tray. Dishes should be shifted in the oven to ensure even cooking.
	2. Hot Dog	1-4	Make 3 slits on each hot dog. Place hot dog on paper plate or microwave-safe dish leaving space between each. Times may vary by size and manufacturer.
	3. Frozen Pizza	4, 8 oz.	Follow manufacturers' directions for preparation. For 2 Level Cooking, dishes should be shifted in the oven to ensure even cooking.
	4. Frozen Pizza Ⓛ	4, 8 oz.	
	5. Frozen Entrées	8, 10, 20, 32 oz.	Follow manufacturer's directions for preparation of 8 and 10 oz. sizes. For larger entrées, where the directions state for the entire film cover to be removed, do not vent or remove film cover to ensure the sensor will detect accurately for complete cooking. Be careful when removing the film cover after cooking. Remove them away from you to avoid steam burns. For 2 Level Cooking, dishes should be shifted in the oven to ensure even cooking.
	6. Frozen Entrées Ⓛ	8, 10, 20, 32 oz.	
Side Dish	1. Potatoes	4 maximum (6-8 oz. each)	Pierce at least 6 times on top of the potato with a fork. Place potatoes on a microwave-safe dish.
	2. Potatoes Ⓛ	4 X 2 maximum	Do not cover. Let stand 5 minutes to complete cooking.
	3. Fresh Vegetables	1/4 - 1 lb.	All pieces should be the same size. Add a small amount of water and cover loosely with lid or vented plastic wrap.
	4. Fresh Vegetables Ⓛ	1/4 - 1 lb.	
	5. Canned Vegetables	15 oz. can size	Empty contents into microwave-safe serving bowl. Cover loosely with lid or vented plastic wrap.
	6. Canned Vegetables Ⓛ	15 oz. can size	
	7. Frozen Vegetables	6-16 oz.	Follow manufacturers' directions. Do not salt until after cooking. (Not suitable for vegetables in butter or sauce. After 2 beeps, stir or rearrange.
	8. Frozen Vegetables Ⓛ	6-16 oz.	
	9. White Rice	1/2 - 1 1/2 cups	Place rice with hot water in a microwave-safe casserole dish. Cover loosely with lid or vented plastic wrap. Let stand 5 to 10 minutes before serving.
	10. Brown Rice	1/2 - 1 1/2 cups	

Sensor Cook Chart

Ⓛ Indicates 2 Level Cooking

Pad	Recipe	HINTS
Dinner	1. Curried Chicken/ White Rice Ⓛ	Prepare according to recipes found on page 17. Place Curried Chicken on top of 2 Level Cooking Rack. Place White Rice in microwave-safe casserole dish. Place on top of Glass tray. After 2 beeps, stir chicken. Re-cover and press Start . Let both dishes stand 10 minutes before serving. Dishes should be shifted in the oven to ensure even cooking.
	2. Rotini with Pesto/ French Green Beans and Mushrooms Ⓛ	Prepare according to recipes found on page 17. Place Green Beans on top of 2 Level Cooking Rack. Place Rotini on top of Glass Tray. After cooking, stir Pesto Sauce into drained noodles.
	3. Salmon Fillets with Dill/ Frozen Vegetables Ⓛ	Prepare according to recipes found on page 18. Place Salmon Fillets on top of 2 Level Cooking Rack. Place Frozen Vegetables in a microwave-safe serving bowl on top of Glass Tray. Let both dishes stand 5 minutes before serving. Dishes should be shifted in the oven to ensure even cooking.
	4. Gingered Chicken/ Parsley-Mushroom Rice Ⓛ	Prepare according to recipes found on page 18. Place Parsley Mushroom Rice on top of 2 Level Cooking Rack. Place Gingered Chicken on top of Glass Tray. Let both dishes stand 10 minutes before serving. Dishes should be shifted in the oven to ensure even cooking.
	5. Stuffed Meat Loaf	Prepare according to recipe found on page 18. Let stand 5 minutes before serving. For 2 Level Cooking, dishes should be shifted in the oven to ensure even cooking. (Note: The dish placed on top of the 2 Level Cooking Rack should be covered with vented plastic wrap. The dish placed on top of the Glass Tray should be covered with vented aluminum foil.)
	6. Stuffed Meat Loaf Ⓛ	
	7. Chicken Parmigiana	Prepare according to recipe found on page 19. After 2 beeps, turn chicken and add toppings. Re-cover and press Start . Let stand 5 minutes before serving. For 2 Level Cooking, dishes should be shifted in the oven to ensure even cooking.
	8. Chicken Parmigiana Ⓛ	
	9. Stuffed Pork Chops	Prepare according to recipe found on page 19. Let stand 5 minutes before serving.
	10. Stuffed Pork Chops Ⓛ	
	11. Shrimp Creole	Prepare according to recipe found on page 19. After 2 beeps, stir. Re-cover and press Start . Let stand 5 minutes before serving.
	12. Shrimp Creole Ⓛ	
	13. Vegetable Medley	Prepare according to recipe found on page 19. After 2 beeps, stir. Re-cover and press Start . Let stand 5 minutes before serving. For 2 Level Cooking, dishes should be shifted in the oven to ensure even cooking.
	14. Vegetable Medley Ⓛ	

Sensor Cook Numbers and Recipes

- Breakfast**
- 1 Ⓛ Breakfast Sausage/Oatmeal
 - 2 Ⓛ Omelet/Bacon
 - 3 Ⓛ Bacon/Oatmeal
 - 4 Breakfast Sausage
 - 5 Breakfast Sausage
 - 6 Oatmeal

- Lunch/Snack**
- 1 Ⓛ Frozen Entrées/Soup
 - 2 Hot Dog
 - 3 Frozen Pizza
 - 4 Ⓛ Frozen Pizza
 - 5 Frozen Entrées
 - 6 Ⓛ Frozen Entrées

- Side Dish**
- 1 Potatoes
 - 2 Ⓛ Potatoes
 - 3 Fresh Vegetables
 - 4 Ⓛ Fresh Vegetables
 - 5 Canned Vegetables
 - 6 Ⓛ Canned Vegetables
 - 7 Frozen Vegetables
 - 8 Ⓛ Frozen Vegetables
 - 9 White Rice
 - 10 Brown Rice

- Dinner**
- 1 Ⓛ Curried Chicken/White Rice
 - 2 Ⓛ Rotini with Pesto/French Green Beans and Mushrooms
 - 3 Ⓛ Salmon Fillets with Dill/Frozen Vegetables
 - 4 Ⓛ Gingered Chicken/Parsley-Mushroom Rice
 - 5 Stuffed Meat Loaf
 - 6 Ⓛ Stuffed Meat Loaf
 - 7 Chicken Parmigiana
 - 8 Ⓛ Chicken Parmigiana
 - 9 Stuffed Pork Chops
 - 10 Ⓛ Stuffed Pork Chops

*See Instruction Manual for Sensor Cook Recipes

- Dinner**
- 11 Shrimp Creole
 - 12 Ⓛ Shrimp Creole
 - 13 Vegetable Medley
 - 14 Ⓛ Vegetable Medley

Ⓛ Indicates 2 Level Cooking Rack

CAUTION: 2 Level Cooking Rack may become HOT during cooking. Use caution when handling 2 Level Cooking Rack

2 Level Cooking Rack

COOKING POSITION:

Open LEGS completely and push until they lock into place.

SAFETY PRECAUTIONS:

1. To avoid tipping, ensure that the LEGS are securely locked.
2. Use covered dishes and place in the center of the rack to prevent tilting and spillage of food.
3. Not for use with a Browning Dish or popcorn bags.
4. Use for recommended recipes only.

STORAGE POSITION:

To release LEGS from locking tabs, push locking tabs outward and fold legs upward until they snap into place.

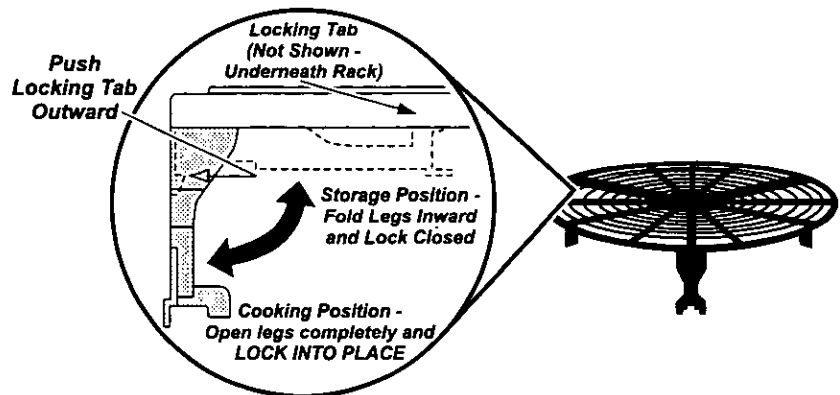

Sensor Cook Recipes

BREAKFAST

Basic Omelet

(Approx. cooking time: 4 minutes)

- 1 tablespoon butter or margarine
- 2 eggs
- 2 tablespoons milk
- Salt and ground black pepper, if desired

Heat butter in a 9-inch pie plate, 30 seconds at P10, or until melted, turn the plate to coat the bottom with butter.

Meanwhile, combine the remaining ingredients; pour into the pie plate. Cook, covered with vented aluminum foil, on OMELET. Let stand 2 minutes. With a spatula, loosen the edges of the omelet from the plate; fold into thirds to serve.

Yield: 1 serving

NOTE: Double ingredients for a 4 egg omelet

DINNER

1. Curried Chicken/White Rice

White Rice

(Approx. cooking time: 23 minutes)

Curried Chicken

- 3 tablespoons all-purpose flour
- 1 tablespoon curry powder
- 1/2 teaspoon ground ginger
- 1/2 teaspoon salt
- 1 pound boneless, skinless chicken breasts, cut into 1-inch cubes
- 1 small chopped onion
- 2-3 tablespoons lemon juice
- 1/4 cup butter or margarine
- 1 teaspoon instant chicken bouillon

Combine together flour, lemon juice, curry, ginger and salt in a small bowl. Set aside. In a 2-Qt. casserole, place cut up chicken combined with onion and lemon juice. Stir in flour mixture until well combined. Add in butter and bouillon.

Cover and place on 2 Level Cooking Rack.

Cook on **DINNER #1 (Curried Chicken/White Rice)**. When the oven beeps, stir chicken. Re-cover, and press **Start**. Let stand 10 minutes. Serve chicken on top of rice.

Yield: 4 servings

White Rice on Bottom

- 1 1/2 cups uncooked long grain rice
- 3 cups hot water

Place both ingredients in 3-Qt. casserole.

Cover and place on Glass Tray. Cook on **DINNER #1 (Curried Chicken/White Rice)**. Let stand 5 minutes before serving.

Yield: 4 servings

NOTE: Dishes should be shifted in the oven to ensure even cooking.

2. Rotini with Pesto/French Green

Beans and Mushrooms

(Approx. cooking time: 12 minutes)

French Green Beans and Mushrooms on Top

- 1 package (9 oz.) frozen French style green beans
- 1 can (4 oz.) mushroom pieces and stems, drained (reserve 1 tablespoon liquid)
- 1 tablespoon butter or margarine
- 1/2 teaspoon salt

Place all ingredients in a 1 1/2 Qt. casserole. Cover and place on 2 Level Cooking Rack. Cook on **DINNER #2 (Rotini with Pesto/French Green Beans and Mushrooms)**.

Yield: 4 servings

Rotini with Pesto Sauce on bottom

- 8 ounces uncooked Rotini Noodles
- 8 cups water

In a 3-Qt. casserole, mix together Rotini Noodles with water. Cover and place on Glass Tray. Cook on **DINNER #2 (Rotini with Pesto/French Green Beans and Mushrooms)**.

At the end of cooking, drain noodles and place back into casserole dish.

- 1/2 cup grated Parmesan cheese
- 3 tablespoons dried basil leaves
- 2 tablespoons pine nuts, finely chopped
- 1 clove minced garlic
- 1/2 cup olive oil
- 1/4 teaspoon salt, optional

Combine all ingredients except olive oil in food processor. Mix together while pouring a constant stream of oil, through the opening, until well combined. Stir Pesto sauce into drained noodles.

Yield: 4 servings

How to shift dishes:

e. g. LUNCH/SNACK # 4 (Frozen Pizza)

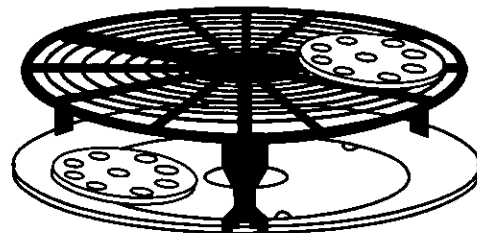

Sensor Cook Recipes

3. Salmon Fillets with Dill/Frozen Vegetables

(Approx. cooking time: 19 minutes)

Salmon Fillets with Dill on Top

- 1/2 cup thinly sliced celery
- 1/4 cup butter or margarine
- 1/4 cup white wine
- 3 tablespoons lemon juice
- 1 teaspoon dill weed
- 1/4 teaspoon salt
- 1/4 teaspoon ground black pepper
- 4 salmon fillets 1-inch thick (about 6 oz. each)

In a 1-Qt. casserole dish, combine together all ingredients except salmon fillets. Cook, covered, on P10 for 5 minutes. Dip each salmon fillet in butter sauce and arrange inside 2.5 Qt. oval casserole dish; with thickest portion toward edge of dish. Spoon remaining sauce over each fillet. Cover and place on 2 Level Cooking Rack. Cook on **DINNER #3 (Salmon Fillets with Dill/Frozen Vegetables)**. At the end of cooking, let stand, covered, 5 minutes before serving. Cover and place on 2 Level Cooking Rack. Cook on **DINNER #3 (Salmon Fillets with Dill/Frozen Vegetables)**. Let stand 5 minutes before serving.

Yield: 4 servings

Frozen Vegetables on bottom

- 1 package (16 oz.) frozen vegetables
- 2 tablespoons water

In a 9-inch round cake dish, combine frozen vegetables and water. Cover and place on Glass Tray. Cook on **DINNER #3 (Salmon Fillets with Dill/Frozen Vegetables)**. Let stand 5 minutes before serving.

Yield: 4 servings

4. Gingered Chicken/Parsley-Mushroom Rice

(Approx. cooking time: 27minutes)

Parsley-Mushroom Rice on top

- 3 cups hot water
- 1 1/2 cups uncooked long grain rice
- 1/2 cup finely chopped green onion
- 1/4 cup butter or margarine
- 3 tablespoons dried parsley flakes
- 1 tablespoon instant chicken bouillon
- 1 teaspoon dried basil leaves
- 1 can (4 oz.) mushroom pieces and stems, drained
- 2 small cloves garlic, finely chopped
- Grated Parmesan cheese (if desired)

Combine all ingredients in 2-Qt. casserole. Cover and place on 2 Level Cooking Rack. Cook on **DINNER #4 (Gingered Chicken/Parsely Mushroom Rice)**. Let stand 5 minutes before serving.

Yield: 6 servings

Gingered Chicken on bottom

- 2 pounds chicken drumsticks, skinned
- 1/3 cup honey
- 1/3 cup chili sauce
- 1/3 cup soy sauce
- 1 teaspoon ground sugar
- 1/2 teaspoon salt
- 1/4 teaspoon ground black pepper
- 1 tablespoon cornstarch
- 2 tablespoons cold water

Arrange chicken pieces with thickest parts toward the outside edge of 2.5-Qt. oval casserole dish. Mix remaining ingredients except cornstarch and water; pour over chicken. Cover and place on Glass Tray. Cook on **DINNER#4 (Gingered Chicken/Parsely-Mushroom Rice)**. At the end of cooking, remove chicken to serving platter; keep warm. Mix cornstarch and water; stir into sauce. Microwave, covered, on P10 for 2 minutes. Stir every minute until thickened. Pour sauce over chicken.

Yield: 6 servings

NOTE: Dishes should be shifted in the oven to ensure even cooking.

5,6. Stuffed Meat Loaf

- 1 1/2 pounds lean ground beef
- 1 can (15 oz.) tomato sauce, divided
- 1 egg
- 1/3 cup seasoned dry bread crumbs
- 1/4 cup chopped green onions
- 2 cups finely chopped celery
- 1/4 teaspoon ground black pepper
- 1 cup (4 oz.) shredded mozzarella cheese
- 2 thin slices boiled ham
- 2 chopped stuffed green olives

In medium bowl, combine ground beef, 1 cup tomato sauce, egg, bread crumbs, onion, celery and pepper; mix well. In 9 x 5-inch loaf pan, shape half of meat mixture into bottom of pan. Top with cheese, ham and olives, Spread remaining meat mixture on top and pour remaining sauce over loaf.

TO COOK BY DINNER-5:

(Approx. cooking time: 25 minutes)

Cook, covered, on **DINNER #5 (Stuffed Meat Loaf)**. Let stand, 5 minutes, before serving.

TO COOK BY DINNER-6 - 2 LEVEL:

(Approx. cooking time: 55 minutes)

Follow instructions above. Prepare two individual recipes. Using the **2 Level Cooking Rack**, place one dish on the Glass Tray and the other on top of the **Rack**. Let stand, 5 minutes, before serving.

Yield: 6 servings

NOTE:

- 1) Dishes should be shifted in the oven to ensure even cooking.
- 2) The dish placed on the 2 Level Cooking Rack should be covered with vented plastic wrap. The dish placed on top of the Glass Tray should be covered with foil.

Sensor Cook Recipes

7,8. Chicken Parmigiana

- 1 egg
- 1/4 cup water
- 2 tablespoons vegetable oil, divided
- 1 cup seasoned dry bread crumbs
- 1/2 cup grated Parmesan cheese
- 1/4 teaspoon paprika
- 2 boneless skinless chicken breasts, halved (about 1 pound)
- 1 can (8 oz.) tomato sauce or 1 cup spaghetti sauce
- 1 cup (4 oz.) shredded mozzarella cheese
- Oregano leaves

Beat egg with water. In a separate bowl, combine bread crumbs, Parmesan cheese and paprika. Dip chicken in bread crumb mixture, then in egg mixture and again in bread crumb mixture. Coat bottom of 8-inch square baking dish with 1 tablespoon oil. Place coated chicken in dish; sprinkle with remaining oil.

To Cook by DINNER-7

(Approx. cooking time: 12 minutes)

Cook, covered, on **DINNER #7 (Chicken Parmigiana)**.

When the oven beeps, turn chicken and top with tomato sauce, oregano and cheese. Re-cover and press **Start**. Let stand 5 minutes before serving.

To Cook by DINNER-8 - 2 Level:

(Approx. cooking time: 22 minutes)

Follow instructions above. Prepare two individual recipes.

Using the **2 Level Cooking Rack**, place one dish on the Glass Tray and the other on top of the **Rack**.

Yield: 4 servings

NOTE: Dishes should be shifted in the oven to ensure even cooking.

9, 10. Stuffed Pork Chops

- 1/4 cup thinly sliced celery
- 1/4 cup thinly sliced onion
- 2 tablespoons butter or margarine
- 1 1/2 cups seasoned croutons
- 1/4 cup water
- 4 thin rib pork chops, 1/4 - 1/2-inch thick
- Browning sauce
- Ground black pepper

In a small bowl, combine celery, onion and butter. Cook, covered, on P10 for 3 to 4 minutes, or until vegetables are tender. Add croutons and water; stir until absorbed. Place crouton mixture in the middle of each chop, fold over edges and secure with wooden toothpicks. Place chops, open-side up, in an 11 x 7-inch rectangular baking dish. Brush chops with browning sauce, season with pepper.

To Cook by Dinner-9:

(Approx. cooking time: 11 minutes)

Cook, covered, on **DINNER #9 (Stuffed Pork Chops)**. Let stand 5 minutes before serving.

To Cook by Dinner 10 - 2 Level:

(Approx. cooking time: 22 minutes)

Follow instructions above. Prepare two individual recipes. Using the **2 Level Cooking Rack**, place one dish on the Glass Tray and the other on top of the **Rack**. Follow instructions above.

Yield: 4 servings per recipe

11,12. Shrimp Creole

- 1/2 cup each finely chopped celery, green bell pepper and onion
- 1 pound medium shrimp, shelled and deveined
- 1 can (15 oz.) tomato sauce
- 2 cloves minced garlic
- 1 teaspoon salt
- 1 teaspoon hot pepper sauce
- 1/4 teaspoon ground black pepper

To Cook by DINNER-11

(Approx. cooking time: 8 minutes)

In a 2-Qt. casserole, combine all ingredients. Cook, covered, on **DINNER #11 (Shrimp Creole)**. When the oven beeps, stir. Re-cover and press **Start**. Let stand 5 minutes before serving.

To Cook by DINNER-12 - 2 Level:

(Approx. cooking time: 23 minutes)

Follow instructions above. Prepare two individual recipes.

Using the **2 Level Cooking Rack**, place one dish on the Glass Tray and the other on top of the **Rack**.

Yield: 4 servings

13, 14. Vegetable Medley

- 4 medium zucchini (about 6 oz. each), sliced 1/4 - inch thick
- 4 stalks celery finely chopped
- 2 medium onions, sliced, separated into rings
- 1 can (15 oz.) tomato sauce
- 1 cup chopped green bell pepper
- 1/2 teaspoon salt
- 1/4 teaspoon garlic powder
- 1/4 teaspoon oregano
- 1/4 teaspoon ground black pepper
- 1/4 cup grated Parmesan cheese

In a 3-Qt. casserole dish, combine all ingredients except Parmesan cheese; mix well.

To Cook by DINNER-13

(Approx. cooking time: 33 minutes)

Cook, covered, on **DINNER #13 (Vegetable Medley)**.

When the oven beeps, stir. Re-cover and press **Start**. Let stand 5 minutes. Top with cheese before serving.

To Cook by DINNER-14 -2 Level

(Approx. cooking time: 1 hour)

Follow instructions above. Prepare two individual recipes.

Using the **2 Level Cooking Rack**, place one dish on the Glass Tray and the other on top of the **Rack**.

Yield: 4 servings per recipe

Note: Dishes should be shifted in the oven to ensure even cooking.

Food Characteristics

Bone and Fat

Both bone and fat affect cooking. Bones may cause irregular cooking. Meat next to the tips of bones may overcook while meat positioned under a large bone, such as a ham bone, may be undercooked. Large amounts of fat absorb microwave energy and the meat next to these areas may overcook.

Density

Porous, airy foods such as breads, cakes or rolls take less time to cook than heavy, dense foods such as potatoes and roasts. When reheating donuts or other foods with different centers be very careful. Certain foods have centers made with sugar, water or fat and these centers attract microwaves (For ex., jelly donuts). When a jelly donut is heated, the jelly can become extremely hot while the exterior remains warm to the touch. This could result in a burn if the food is not allowed to cool properly in the center.

Quantity

Two potatoes take longer to cook than one potato. As the quantity of the food increases so does the cooking time. When cooking small amounts of food such as one or two potatoes, do not leave oven unattended. The moisture content in the food may decrease and a fire could result.

Shape

Uniform sizes heat more evenly. The thin end of a drumstick will cook more quickly than the meaty end. To compensate for irregular shapes, place thin parts toward the center of the dish and thick pieces toward the edge.

Size

Thin pieces cook more quickly than thick pieces.

Starting Temperature

Foods that are room temperature take less time to cook than if they are chilled or refrigerated or frozen.

Cooking Techniques

Piercing

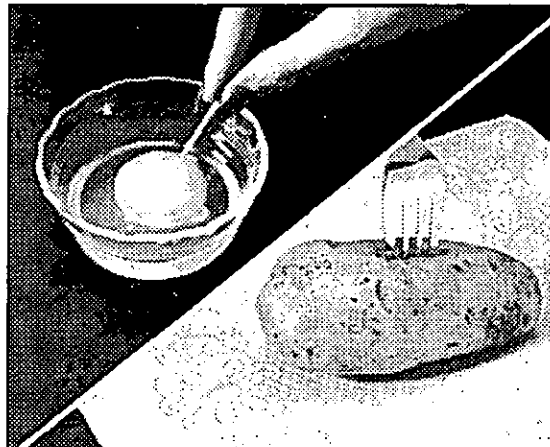

Foods with skins or membranes must be pierced, scored or have a strip of skin peeled before cooking to allow steam to escape. Pierce whole egg yolks and whites, clams, oysters, chicken livers, whole potatoes and whole vegetables. Whole apples or new potatoes should have a 1-inch strip of skin peeled before cooking. Score sausages and frankfurters.

Browning



Foods will not have the same brown appearance as conventionally cooked foods or these foods which are cooked utilizing a browning feature. Meats and poultry may be coated with browning sauce, Worcestershire sauce, barbecue sauce or shake-on browning sauce. To use, combine browning sauce with melted butter or margarine; brush on before cooking.

For quick breads or muffins, brown sugar can be used in the recipe in place of granulated sugar, or the surface can be sprinkled with dark spices before baking.

Cooking Techniques

Spacing

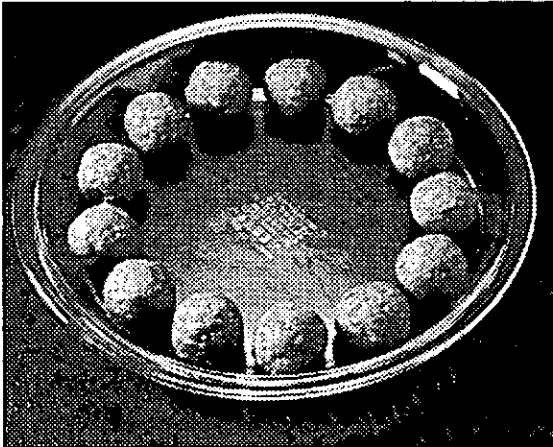

Individual foods, such as baked potatoes, cupcakes and appetizers, will cook more evenly if placed in the oven equal distances apart. When possible, arrange foods in a circular pattern.

Covering



As with conventional cooking, moisture evaporates during microwave cooking. Casserole lids or plastic wrap are used for a tighter seal. When using plastic wrap, vent the plastic wrap by folding back part of the plastic wrap from the edge of the dish to allow steam to escape. Loosen or remove plastic wrap as recipe directs for stand time. When removing plastic wrap covers, as well as any glass lids, be careful to remove them away from you to avoid steam burns. Various degrees of moisture retention are also obtained by using wax paper or paper towels. However, unless specified, a recipe is cooked covered.

Shielding

Thin areas of meat and poultry cook more quickly than meaty portions. To prevent overcooking, these thin areas can be shielded with strips of aluminum foil. Wooden toothpicks may be used to hold the foil in place.

Timing

A range in cooking time is given in each recipe. The time range compensates for the uncontrollable differences in food shapes, starting temperature and regional preferences. Always cook food for the minimum cooking time given in a recipe and check for doneness. If the food is undercooked, continue cooking. It is easier to add time to an undercooked product. Once the food is overcooked, nothing can be done.

Stirring

Stirring is usually necessary during microwave cooking. We have noted when stirring is helpful, using the words once, twice, frequently or occasionally to describe the amount of stirring necessary. Always bring the cooked outside edges toward the center and the less cooked center portions toward the outside of the dish.

Rearranging

Rearrange small items such as chicken pieces, shrimp, hamburger patties or pork chops. Rearrange pieces from the edge to the center and pieces from the center to the edge of the dish.

Turning

It is not possible to stir some foods to redistribute the heat. At times, microwave energy will concentrate in one area of a food. To help insure even cooking, these foods need to be turned. Turn over large foods, such as roasts or turkeys, halfway through cooking.

Stand Time

Most foods will continue to cook by conduction after the microwave oven is turned off. In meat cookery, the internal temperature will rise 5°F to 15°F (3°C to 8°C), if allowed to stand, tented with foil, for 10 to 15 minutes. Casseroles and vegetables need a shorter amount of standing time, but this standing time is necessary to allow foods to complete cooking to the center without overcooking on the edges.

Testing for Doneness

The same tests for doneness used in conventional cooking may be used for microwave cooking. Meat is done when fork-tender or splits at fibers. Chicken is done when juices are clear yellow and drumstick moves freely. Fish is done when it flakes and is opaque. Cake is done when a toothpick or cake tester is inserted and comes out clean. Candy is done when it reaches the proper temperature for each stage of crystallization.

Before Requesting Service

All these things are normal:

The oven causes interference with my TV.

Some radio and TV interference might occur when you cook with the microwave oven. This interference is similar to the interference caused by small appliances such as mixers, vacuums, blow dryers, etc.. It does not indicate a problem with your oven.

The oven light dims.

When cooking with a power other than P10 (HIGH), the oven must cycle to obtain the lower power levels. The oven light will dim and clicking noises can be heard when the oven cycles.

Steam accumulates on the oven door and warm air comes from the oven vents.

During cooking, steam and warm air are given off from the food. Most of the steam and warm air are removed from the oven by the air which circulates in the oven cavity. However, some steam will condense on cooler surfaces such as the oven door. This is normal.

I accidentally ran my microwave oven without any food in it.

Running the oven empty for a short time will not damage the oven. However, we do not recommend operating the microwave oven without any food in it.

PROBLEM

POSSIBLE CAUSE

ACTION

Oven will not turn on.



The oven is not plugged in securely.

Remove plug from outlet, wait 10 seconds and reinsert.

Circuit breaker or fuse is tripped or blown.

Reset circuit breaker or replace fuse.

There is a problem with the outlet.

Plug another appliance into the outlet to check if it is working.

Oven will not start cooking.



The door is not closed completely.

Close the oven door securely.

Start Pad was not pressed after programming.

Press **Start** Pad.

Another program is already entered into the oven.

Press **Stop/Reset** Pad to cancel the previous program and enter new program.

The program is not correct.

Program again according to the Operating Instructions.

Stop/Reset Pad has been pressed accidentally.

Program oven again.

The Glass Tray wobbles.



The Glass Tray is not positioned properly on the Roller Ring(s) or there is food under the Roller Ring(s).

Take out Glass Tray and Roller Ring(s). Wipe with a damp cloth and reset Roller Ring(s) and Glass Tray properly.

When the oven is operating, there is noise coming from the Glass Tray.



The Roller Ring(s) and oven bottom are dirty.

Clean according to **Care of Your Microwave Oven**.

Warranty & Service

PANASONIC/QUASAR MICROWAVE OVEN LIMITED WARRANTY

Panasonic Consumer Electronics Company or Panasonic Sales Company (collectively referred to as "the warrantor") will repair this product with new or refurbished parts in exchange for defective parts, free of charge, in the USA or Puerto Rico from the date of original purchase in the event of a defect in materials or workmanship as follows (all time periods start from the date of original purchase):

Parts - one (1) year (except magnetron).

Magnetron Tube - five (5) years.

Labor - one (1) year on all parts (including, without limitations, magnetron tube). After the labor warranty has expired, the purchaser pays for all labor charges for removal and installation of parts (including, without limitation, magnetron tube).

Carry-in or mail-in service in the USA or Puerto Rico can be obtained during the warranty period by contacting a Panasonic Services Company (PASC) Factory Servicenter listed in the Servicenter Directory. Or call, toll free, **1-800-211-PANA** to locate a PASC authorized Servicenter. Carry-in or mail-in service in Puerto Rico can be obtained during the warranty period by calling the Panasonic Sales Company telephone number listed in the Servicenter Directory.

This warranty is extended only to the original purchaser. A purchase receipt or other proof of date of original purchase will be required before warranty service is rendered.

This warranty only covers failures due to defects in materials or workmanship which occur during normal use and does not cover glass, plastic parts, temperature probes (if included), and the exterior and interior finish. The warranty does not cover damages which occur in shipment, or failures which are caused by products not supplied by the warrantor, or

failures which result from accident, misuse, abuse, neglect, mishandling, misapplication, faulty installation, improper set-up adjustments, operation and/or maintenance, or alteration, modification, power line surge, improper voltage supply, lightning damage, or commercial use such as hotel, office, restaurant or other business or rental use of the product, or service by anyone other than a PASC Factory Servicenter or a PASC authorized Servicenter, or damage that is attributable to acts of God.

LIMITS AND EXCLUSIONS

There are no express warranties except as listed above. THE WARRANTOR SHALL NOT BE LIABLE FOR INCIDENTAL OR CONSEQUENTIAL DAMAGES RESULTING FROM THE USE OF THIS PRODUCT, OR ARISING OUT OF ANY BREACH OF THIS WARRANTY. ALL EXPRESS AND IMPLIED WARRANTIES, INCLUDING THE WARRANTIES OF MERCHANTABILITY, AND FITNESS FOR A PARTICULAR PURPOSE, ARE LIMITED TO THE APPLICABLE WARRANTY PERIOD SET FORTH ABOVE.

Some states do not allow the exclusion or limitation of incidental or consequential damages, or limitations on how long an implied warranty lasts, so the above exclusions or limitations may not apply to you.

This warranty gives you specific legal rights and you may also have other rights which vary from state to state. If a problem with this product develops during or after the warranty period, you may contact your dealer or Servicenter. If the problem is not handled to your satisfaction, then write to the Customer Satisfaction Center.

Web Site: <http://www.Panasonic.com>

You can purchase parts, accessories or locate your nearest servicenter by visiting our Web Site.

Factory Servicenters Locations

CALIFORNIA
6550 Katella Ave.
Cypress, CA 90630

800 Dubuque Ave.
S. San Francisco,
CA 94080

20201 Sherman Way
Suite 102
Canoga Park, CA 91306

3878 Ruffin Rd., Suite A
San Diego, CA 92123

COLORADO
1640 South Abilene Street
Suite D
Aurora, CO 80012

FLORIDA
3700 North 29th Ave.
Suite 102
Hollywood, FL 33020

GEORGIA
8655 Roswell Road
Suite 100
Atlanta, GA 30350

ILLINOIS
9060 Golf Road
Niles, IL 60714

1703 N. Randall Road
Elgin, IL 60123
(Pick up/Drop off only)

MARYLAND
62 Mountain Road
Glen Burnie, MD 21061

MASSACHUSETTS
60 Glacier Drive, Suite G
Westwood, MA 02090

MICHIGAN
37048 Van Dyke Ave.
Sterling Hts., MI 48312

MINNESOTA
7850-12th Ave. South
Airport Business Center
Bloomington, MN 55425

OHIO
2236 Waycross Road
Civic Center Plaza
Forest Park, OH 45240

PENNSYLVANIA
2221 Cabot Blvd. West
Suite B
Langhorne, PA 19047

TENNESSEE
3800 Ezell Road
Suite 806
Nashville, TN 37211

TEXAS
13615 Welch Road
Suite 101
Farmers Branch,
TX 75244





























WASHINGTON
20425-84th Ave. South
Kent, WA 98032

HAWAII
99-859 Iwaiwa Street
Aiea, Hawaii 96701
Phone (808) 488-1996
Fax (808) 486-4639

Service in Puerto Rico

Matsushita Electric of Puerto Rico, Inc. Panasonic Sales Company / Factory Servicenter
Ave. 65 de Infanteria, Km. 9.5, San Gabriel Industrial Park, Carolina, Puerto Rico 00985
Phone (787) 750-4300 Fax (787) 768-2910

Quick Guide to Operation

Feature	How to Operate
To Set Clock (☛page 9)	 Press. → 0 Thru 9 → Enter time of day. →  Press.
To Cook Using Power and Time (☛page 10)	 Press to select power. → 0 Thru 9 → Set cooking time. →  Press.
To use Function (☛page 8)	 Press. → 0 Thru 9 → Select category. → 1 or 2 or 3 → Select option.
To Defrost using Power & Time (☛page 10)	 Press 8 times to select P 3. → 0 Thru 9 → Enter defrost time. →  Press.
Inverter Turbo Defrost (☛page 11)	 Press. → 0 Thru 9 → Enter weight. →  Press.
To Cook using Popcorn (☛page 11)	 Press to select weight. →  Press.
To Use as a Timer (☛page 10)	 Press. → 0 Thru 9 → Enter time. →  Press.
To Set Standing Time (☛page 10)	(Input up to 4-stage Cooking Program) →  Press. → Stand time. → 0 Thru 9 → Enter time. →  Press.
To Set Delay Time (☛page 10)	 Press. → Delay time. → 0 Thru 9 → Enter time. → (Input up to 4-stage Cooking Program) →  Press.
To Cook using Quick Min (☛page 9)	 Tap desired number of times (up to 10). →  Press.
To Cook using Sensor Cook (☛page 12)	 Press. → 0 Thru 9 → Select desired category (1-14). →  Optional. →  Optional on selected recipes. →  Press.
To Reheat using Sensor Reheat (☛page 12)	 Press. →  Optional. →  Press.
To use Keep Warm (☛page 9)	 Press to select category. →  Press. →  Press.

Panasonic®

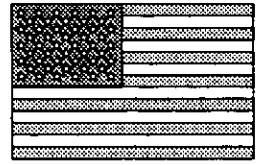

Manual de Instrucciones

Horno Microondas
Modelo NN-S780BA/BAS/WA/WAS

INVERTER
SYSTEM INSIDE

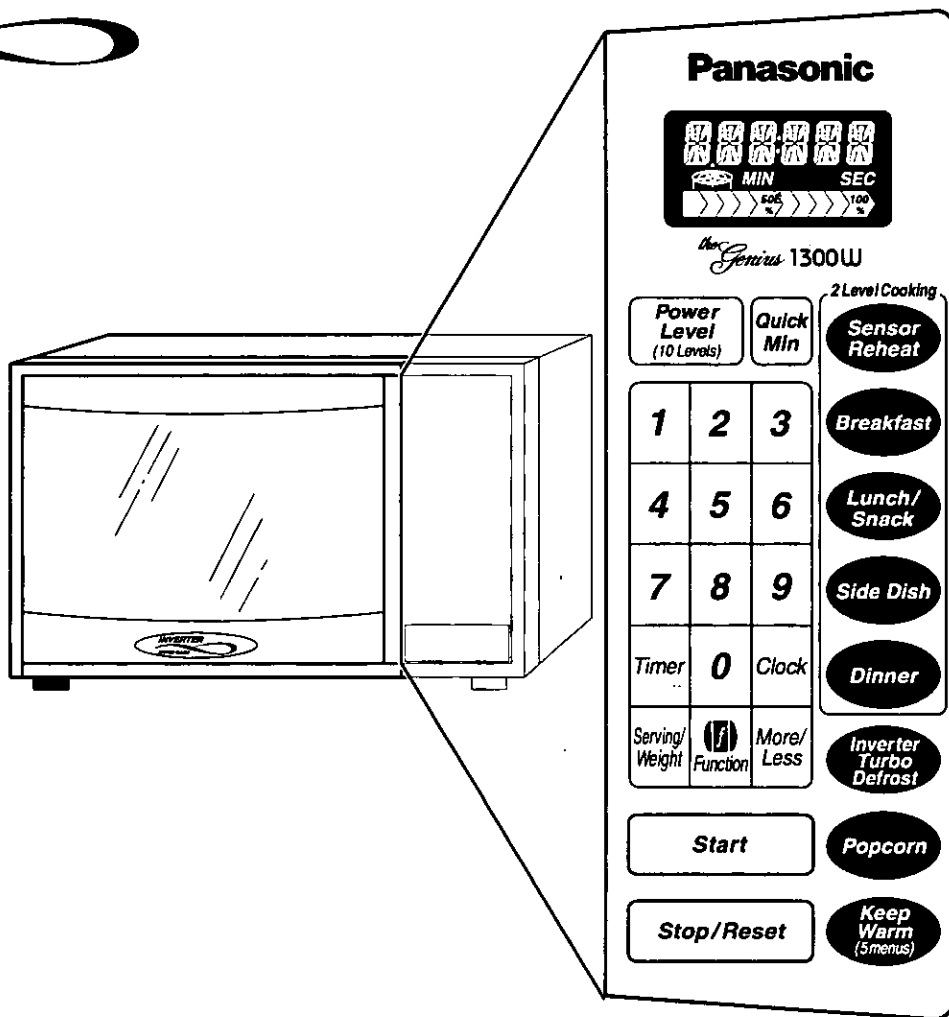

Este manual contiene Instrucciones de Seguridad.
Instrucciones de operación y mantenimiento del horno.

Antes de operar este producto, lea este instructivo en su totalidad.

B00034W00AP
Impreso en E.U.A.

PRECAUCIONES PARA EVITAR UNA POSIBLE EXPOSICIÓN A UNA ENERGÍA DE MICROONDAS EXCESIVA

- (a) No intente utilizar este horno con la puerta abierta, ya que el funcionamiento con la puerta abierta puede provocar una exposición dañina a la energía del microondas. Es importante no intentar anular o manipular los bloqueos de seguridad. Bajo condiciones normales, el horno no funcionará con la puerta abierta.
- (b) No coloque ningún objeto entre la parte frontal del horno y la puerta, o permita que se acumule un residuo de suciedad o de productos de limpieza en las superficies de cierre.
- (c) No utilizar el horno si está averiado. Es particularmente importante que la puerta del horno cierre correctamente y que no se produzca ningún desperfecto en:
 - (1) puerta (doblada)
 - (2) bisagras y pestillos (rotas o sueltos)
 - (3) las juntas de la puertas y las superficies de cierre.
- (d) El horno no se debería ajustar o reparar por nadie, con excepción del personal técnico debidamente calificado.

ENGRABE SU NOTA DE COMPRA AQUI.

GRACIAS POR COMPRAR ESTE HORNO DE MICROONDAS PANASONIC.

Modelo n.º _____

Serie n.º _____

Fecha de Compra _____

Table des matières

Antes de Operar

Precauciones	Inside front cover
Instrucciones de Seguridad Importantes	2
Instrucciones de Instalación	3
Sugerencias Útiles	4
Diagrama de Características	7
Panel de Control	7

Operación

Función	8
Vamos a empezar a usar su horno	9
Para Ajuste del Reloj	9
Para seleccionar Potencia y Tiempo	9
Minuto automático	9
Temporizador	10
Pulsador de Palomitas de Maíz	10
Descongelación Turbo Inverter	11
Recalentamiento Automático	11

Consejos Para Cocinar

Guía para Cocinar y Utensilios	5
Consejos y Técnicas de Descongelación	13
Consejos Rápidos	14

Mantenimiento

Especificaciones Técnicas	1
Cuidado de Su Horno de Microondas	6
Antes de Solicitar Servicio Técnico	15

Especificaciones Técnicas

	NN-S780
Potencia Fuente de Poder:	120V~ 60 Hz
Potencia de Consumo:	12,0 ampères 1 400 W
Potencia de Salida:	1 300 W
Outside Dimensions: (H x W x D)	11 ¹⁵ / ₁₆ " (H) X 21 ⁷ / ₈ " (W) X 19 ⁹ / ₁₆ " (D) 304mm (H) X 555mm (W) X 497mm (D)
Oven Capacity Dimensions: (H x W x D)	9" (H) x 16 ⁷ / ₁₆ " (W) X 18 ¹ / ₂ " (D) 228mm (H) x 418mm (W) X 470mm (D)
Frecuencia:	2 450 MHz
Peso Sin Embalaje:	14,3 kg (32 lb)

INSTRUCCIONES DE SEGURIDAD IMPORTANTES

Su horno de microondas es un dispositivo de cocción, y debe ejercer las mismas precauciones que se utilizan con un hornillo de cocina o con cualquier otro dispositivo utilizado para cocinar. Cuando utilice este electrodoméstico, es necesario respetar las precauciones de seguridad básicas, incluyendo las siguientes:

ADVERTENCIA—Para reducir el riesgo de quemaduras, electrocuciones, fuegos, lesiones a personas o exposición a una energía de microondas excesiva:

1. Leer todas las instrucciones antes de utilizar el electrodoméstico.
2. Leer seguir las "PRECAUCIONES PARA EVITAR LA POSIBLE EXPOSICIÓN A UNA ENERGÍA DE MICROONDAS EXCESIVA", que se encuentran en el anverso de la tapa frontal.
3. Este electrodoméstico se debe conectar a tierra. Conectar solamente a la toma conectada a tierra correctamente. Consultar "INSTRUCCIONES PARA LA CONEXIÓN A TIERRA".
4. Instalar o colocar este electrodoméstico de acuerdo con las instrucciones de instalación que se encuentran.
5. No cubrir o bloquear ninguna apertura de este electrodoméstico.
6. No almacenar este electrodoméstico en el exterior. No utilizar este producto cerca del agua - por ejemplo, cerca del fregadero de una cocina, en sótanos húmedos, o cerca de una piscina y lugares similares.
7. Utilizar este electrodoméstico solo para el empleo descrito en este manual. NO utilizar productos químicos corrosivos, vapores o productos no alimenticios en este electrodoméstico. Este tipo de horno se diseñó específicamente para calentar o cocer, no está diseñado para utilizations industriales o de laboratorio. El empleo de productos químicos corrosivos en el calentamiento o limpieza dañará el electrodoméstico y puede producir fugas de radiación.
8. Cuando limpie las superficies de la puerta y del horno que se juntan al cerrar la puerta, utilizar solamente detergentes o jabones suaves y no abrasivos aplicados con una esponja o un trapo blando.
9. No permitir que los niños utilicen este electrodoméstico, a no ser que estén supervisados estrechamente por un adulto.
10. No utilizar este electrodoméstico si posee un cable de alimentación o enchufe dañado, o si no funciona correctamente o si ha sido dañado, o ha caído al suelo.
11. No sumergir el cable de alimentación o el enchufe en agua.
12. Mantener el cable de alimentación apartado de las superficies calentadas.
13. No dejar que el cable de alimentación cuelgue sobre el borde de una mesa o mostrador.
14. El servicio técnico de este electrodoméstico solo puede ser realizado por personal de servicio técnico calificado. Contactar el centro de servicio técnico más cercano para su examen, reparación o ajuste.

15. Algunos productos, como los huevos enteros, botellas con cuello estrecho y envases sellados - por ejemplo, jarras de vidrio cerradas - pueden explotar y no deben ser calentados en este horno.
15. Para reducir el riesgo de incendios en la cavidad del horno:
 - (a) No cocinar excesivamente los alimentos. Atender cuidadosamente el electrodoméstico en el caso de que se haya colocado papel, plástico u otros materiales combustibles en el interior del horno para facilitar la cocción.
 - (b) Antes de colocar la bolsa en el horno, extraer los alambres que se tuercen y que sirven para cerrar estos elementos.
 - (c) En el caso de que exista la posibilidad de que se incendien los materiales en el horno, mantener la puerta del horno cerrada, apagar el horno y desconectar el cable de alimentación, o desconectar la alimentación en el panel de fusibles o del magnetotérmico.

Utilización General

1. NO manipular o realizar ningún ajuste o reparación en la puerta, alojamiento del panel de control, conmutadores de interbloqueo de seguridad o cualquier otra parte del horno. NO extraer el panel exterior del horno. Las reparaciones solo se deben realizar por personal de servicio técnico cualificado.
2. NO utilizar el horno si está vacío. La energía de microondas se reflejará continuamente por todo el horno, provocando un sobrecalentamiento, si los alimentos o el agua no están presentes para absorber la energía. Esto podría dañar el horno e incluso provocar incendios.
3. NO secar ropa, periódicos u otros materiales en el horno, o utilizar periódicos o bolsas de papel para la cocción. Esto último podría provocar un incendio.
4. NO utilizar productos de papel reciclado, a no ser que el producto de papel esté etiquetado como producto seguro para su empleo en un horno de microondas. Los productos de papel reciclado pueden contener impurezas que pueden provocar chispas y provocar incendios cuando se utilicen.
5. No golpear el panel. Esto podría provocar desperfectos en los controles, lo que podría provocar un incendio.
6. LAS SUJECIONES DE CAZUELAS siempre se deben utilizar cuando se extraen artículos del horno. El calor se transfiere desde los alimentos CALIENTES al envase de cocción y desde el envase de cocción a la Bandeja de Cristal. La Bandeja de Cristal puede estar muy CALIENTE después de extraer el envase de cocción del horno.
7. NO almacenar materiales inflamables al lado, encima o en el horno. Esto podría representar un riesgo de incendios.

GUARDAR ESTAS INSTRUCCIONES

Para el uso adecuado de su horno, leer las precauciones de seguridad restantes y las instrucciones de operación.

INSTRUCCIONES DE INSTALACION

Examine Su Horno

Desempaque su horno, extraer todo el material de embalaje y examine el horno en busca de cualquier tipo de desperfecto como señales de golpes, pestillos de puerta rotos o grietas en la puerta. Notificar al distribuidor inmediatamente si el horno está averiado. NO instalar el horno si está averiado.

Colocación del Horno

1. El horno se debe colocar en una superficie plana y estable. Para que funcione correctamente, el horno deberá poseer una circulación de aire suficiente. Deje un espacio de 3 pulgadas (7,6 centímetros) en ambos lados del horno y 1 pulgada (2,5 centímetros) de espacio en la parte superior del horno.
 - a. NO bloquee las ventilaciones de aire. Si están bloqueados durante la operación, el horno se puede sobrecalentar. Si el horno se sobrecalienta, un dispositivo de seguridad térmico apagará el horno. El horno permanecerá inoperable hasta que se haya enfriado.
 - b. NO colocar el horno cerca de una superficie caliente y húmeda como por ejemplo, la ventilación de dispositivos eléctricos o de gas.
 - c. NO UTILIZAR el horno cuando la humedad ambiente sea demasiado alta.
2. Este horno ha sido fabricado para uso en el hogar solamente.

INTERFERENCIAS EN LA RADIO/TELEVISIÓN

1. La operación del horno de microondas puede provocar interferencias en su radio, televisión o equipos similares.
2. Cuando existan interferencias, se puede reducir o eliminar por medio de tomar las siguientes medidas:
 - a. Limpie la puerta y las superficies de cierre del horno. (Consultar Cuidado del horno microondas).
 - b. Colocar la radio, televisión, etc, lejos del horno de microondas, tan lejos como sea posible.
 - c. Utilizar una antena instalada correctamente para obtener una recepción de señal más fuerte.

BANDEJA DE CRISTAL

1. NO utilizar el horno sin el Aro de Rodillo y la Bandeja de Cristal en su lugar.
2. NO utilizar el horno sin la Bandeja de Cristal perfectamente acoplada sobre el cubo de accionamiento. Esto podría provocar una cocción incorrecta o daños en el horno. Verificar si la Bandeja de Cristal está correctamente acoplada y en rotación por medio de observar su rotación cuando se pulsa **Encender**.
3. Utilizar solamente la Bandeja de Cristal diseñada específicamente para este horno. No la sustituya por otra bandeja de cristal.
4. Si la Bandeja de Cristal está caliente, permitir que se enfríe antes de limpiar o de colocar en el agua.
5. NO cocinar directamente sobre la Bandeja de Cristal. Colocar siempre los alimentos en un plato que resulte seguro para su empleo en hornos microondas, o en las rejillas de un plato para microondas.
6. Si los alimentos o el utensilio colocado en la Bandeja de Cristal toca las paredes del horno, deteniendo el movimiento de la bandeja, la bandeja se pondrá en rotación automáticamente en la dirección opuesta. Esto es normal.
7. La Bandeja de Cristal puede girar en cualquiera de las direcciones.

ARO DEL RODILLO

1. El Aro del Rodillo y el suelo del horno se debe limpiar frecuentemente, para impedir un ruido excesivo.
2. El Aro del Rodillo siempre se debe utilizar en la cocción conjuntamente con la Bandeja de Cristal.
3. Volver a colocar siempre el Aro del Rodillo y la Bandeja de Cristal en sus posiciones adecuadas.

Sugerencias Útiles

Seguir estas instrucciones de seguridad cuando cocine en su horno.

IMPORTANTE

La cocción correcta depende de la potencia, el tiempo ajustado y la cantidad de elementos. Si utiliza una porción más pequeña que la recomendada y realiza una cocción durante el tiempo estipulado para la porción recomendada, esto podría provocar un incendio.

1) CONSERVAS CASERAS / DESHIDRATACIÓN DE ALIMENTOS CANTIDADES PEQUEÑAS DE ALIMENTOS.

- NO utilizar el horno para el enlatado casero, su horno no puede mantener los alimentos a la temperatura de enlatado correcta. Los alimentos enlatados incorrectamente se pueden estropear y resultar peligrosos para el consumo.
- NO secar carnes, hierbas medicinales o aromáticas, frutas o vegetales en su horno. Pequeñas cantidades de alimentos o alimentos con un contenido bajo de humedad se pueden secar, quemarse y provocar un fuego.

2) PALOMITAS DE MAÍZ

Las palomitas de maíz se pueden preparar en un recipiente especializado que sirve para preparar palomitas de maíz en hornos microondas, también se puede disponer de palomitas de maíz que se cocinan en su propia bolsa. Seguir las instrucciones del fabricante de microondas y utilizar una marca apropiada para la potencia de su horno de microondas.

CUIDADO: Cuando utilice las palomitas de maíz ya envasadas, seguir las instrucciones que se recomiendan en el paquete. Comprobar el peso del paquete antes de utilizar la tecla Palomitas (consultar la sección sobre la Tecla de Palomitas). Ajustar el horno para el peso del paquete de palomitas.

Si no se respetan estas instrucciones, puede que las palomitas no se cocinen bien o éstas podrían inflamarse y provocar un incendio. Nunca deje el horno sin atención cuando prepare palomitas de maíz. Deje que las palomitas se enfríen antes de abrir, abrir siempre la bolsa apartándola de su cara para impedir las quemaduras provocadas por el vapor.

3) FREIDURIAS

- NO intente nunca freír con una gran cantidad de aceite o grasa en su horno de microondas. Los aceites se pueden inflamar y saltar en llamas, lo que puede provocar desperfectos en el horno y quemaduras en el usuario. Puede que los utensilios del microondas no puedan soportar la temperatura del aceite caliente, y podrían quedar destrozados o derretirse.

4) ALIMENTOS CON PIELS NO POROSAS

- Las papas, manzanas, huevos enteros, yemas de huevo, calabacines enteros y longanizas son ejemplos de alimentos con pieles no porosas. Estos tipos de alimentos se deben perforar antes de prepararlos en el microondas, para así impedir que exploten.
- Emplear papas frescas para hornear y cocinar hasta que estén hechas. Utilizar los pesos recomendados para la cocción programada. La cocción excesiva puede provocar la deshidratación y provocar incendios.

5) LÍQUIDOS

- Los líquidos calientes pueden estallar si no se mezclan con aire. NO calentar líquidos en su microondas sin antes agitarlos.

6) BANDEJA DE CRISTAL / UTENSILIOS DE COCCIÓN / HOJA METÁLICA

- Los utensilios de cocina se calientan durante la acción del horno microondas. El calor se transfiere desde los alimentos CALIENTES al envase y la Bandeja de Cristal. Utilizar sujeciones de cazuelas y sartenes cuando se extraigan utensilios del horno, o cuando se extraigan tapas o cubiertas de envoltura plástica de los utensilios de cocina, para así evitar quemaduras.
- La Bandeja de Cristal se calienta durante la cocción. Es necesario permitir que se enfríe antes de su manipulación o antes de que los productos de papel, como las placas de papel o las bolsas de palomitas para microondas, se coloquen en el horno de microondas para su preparación.
- Cuando se utilice hoja de aluminio, brochetas, rejillas para calentar o utensilios de metal en el horno, dejar al menos 1 pulgada de espacio (2,5 cm) entre el material de metal y las paredes interiores del horno. Si se producen chispas, extraer los materiales de metal (brochetas, etc.) y/o transferir a un envase metálico.
- No utilizar platos con adornos de metal, ya que se podrían producir chispas.
- Si se calienta un plato en una bandeja de papel de aluminio, mantenerlo a una distancia mínima de 1 pulgada (2,5 cm) de las paredes del horno.

7) TOALLAS DE PAPEL/TRAPOS

- NO utilizar toallas de papel o trapos que incluyan una fibra sintética. La fibra sintética puede provocar la ignición de la toalla. Utilizar toallas de papel bajo supervisión.

8) PLATOS DE DORAR / BOLSAS PARA COCINAR EN HORNO

- Los platos de dorar o grills fueron diseñados para su uso exclusivo en microondas. Seguir siempre las instrucciones proporcionadas por el fabricante. NO precalentar el plato de dorar durante más de 6 minutos.
- Si se utiliza una bolsa para cocinar en horno en el horno microondas, preparar de acuerdo con las instrucciones del paquete. NO utilizar un alambre de torsión para cerrar la bolsa, utilizar solamente cierres de plástico, cuerdas de algodón o una tira cortada del extremo abierto de la bolsa.

9) TERMÓMETROS

- NO utilizar un termómetro para carnes convencional en su horno. Puede provocar chispas. Se pueden disponer de termómetros ya preparados para los hornos microondas tanto para carnes como para dulces.

10) FÓRMULA/ALIMENTOS PARA BEBES

- NO calentar las fórmulas o alimentos para el bebe en un horno de microondas. El envase de cristal o la superficie puede aparentar estar tan solo tibia, mientras que el interior puede estar lo suficientemente caliente como para quemar la boca y el esófago del niño.

11) RECALENTAMIENTO DE PRODUCTOS DE PASTERERÍA

- Cuando recaliente productos de pastelería, comprobar las temperaturas de cualquier relleno antes de comer. Algunos alimentos poseen rellenos que se pueden calentar más rápidamente y pueden estar extremadamente calientes, mientras que la superficie permanece tibia al tacto. (Ejemplo: Donuts con Mermelada).

12) DIRECTRICES GENERALES PARA EL EMPLEO DEL HORNO

- NO utilizar el horno por ninguna otra razón que no sea la preparación de alimentos.
- NO deje el horno sin atención durante su empleo.

Guía para Cocinar y Utensilios

ARTICULO	MICROONDAS	DORAR	COMENTARIOS
Papel Aluminio	Si, para Protección	Si	Pequeñas partes de aluminio pueden ser moldeadas alrededor de partes delgadas de comida o aves para prevenir que se cocinen demasiado. Se puede producir el arco si el aluminio esta muy cercano a las paredes del horno o si se usa demasiado.
Platillos Dorados	Si	No	Los platillos dorados estan diseñados para cocinar en microondas solamente. Revise la información de platillos dorados para ver las instrucciones y el cuadro de calor. No precaliente por más de 8 minutos.
Bolsas de Papel de Estraza	No	No	Puede causar un incendio en el horno.
Servicio de Mesa para la Cena Especial para microondas solamente	Si	Revisar*	Revise las instrucciones del fabricante para el uso y cuidado para ver la conveniencia de calentamiento por microondas. Algunos servicios de mesa puedan indicar en la parte trasera de los platos "Resistente a Horno de Microondas".
Poliester Desechable Platos de Cartón	Si	Revisar*	Algunos alimentos congelados se empaacan en estos platos. Pueden ser comprados en tiendas de abarrotes.
Caja de Comida Rápida con Agarradera de Metal	No	No	Puede causar arco.
Bandeja para Comida Congelada Metal Especial para Microondas	Si Si	Si Revisar*	Cenas congeladas pueden ser calentadas en bandejas de aluminio, si la bandeja tiene una altura menor a 2 cm. Coloque la bandeja de aluminio en el centro del horno. Deje al menos un espacio de 2,5 cm entre la bandeja de aluminio y las paredes del horno. Caliente solamente 1 bandeja de aluminio en el horno cada vez. Para contenedores de mas de 2 cm de profundidad, sacar los alimentos y colocarlos en un contenedor de tamaño similar especiales para microondas.
Frascos de Cristal	Si	No	Quite la tapa. Caliente los alimentos solo hasta que esten tibios. La mayoría de los frascos de cristal no son resistentes al calor.
Cristalería y Cerámica para Horno Resistente Al Calor solamente	Si	Si	Ideales para cocinar y dorar en microondas. (Para probar un contenedor para el uso seguro del horno de microondas.)
Sujetadores Metálicos Torcidos	No	No	Pueden causar arco que podría ocasionar un incendio en el horno.
Bolsa para Cocinar en el Horno	Si	No	Siga las instrucciones del fabricante. Cierre la bolsa con los sujetadores de nylon que se proporcionan, con una tira cortada del final de la bolsa, o con un pedazo de cuerda de algodón. No lo cierre, con sujetadores metálicos torcidos. Haga seis cortes de 1,5 cm por el cierre.
Platos de Papel y Servilletas	Si	No	Use para entibiar alimentos cocinados, y para cocinar alimentos que requieran corto tiempo de cocción, tales como salchichas Francfort.
Toallas de Papel y Servilletas	Si	No	Use para entibiar pollos y sandwiches por microondas.
Plástico Especial para Microondas solamente Bateria de Cocina y Platos de Almacenamiento	Si	Revisar*	Deberan estar etiquetados "Adecuados para calentar por microondas" Revise las instrucciones del fabricante para los usos recomendados. Algunos platos plásticos especiales para microondas no son adecuados para cocinar alimentos con altos contenidos de grasa.
Envoltura Plástica	Si	No	Use para cubrir alimentos durante la cocción para retener la humedad.
Popote, Mimbre, Madera	Si	No	Use solamente para recalentar por corto tiempo.
Tazas de Unicel	Si	No	Use para que los alimentos lleguen a la temperatura ideal para servir. El unicel se derretirá si los alimentos alcanzan una temperatura alta.
Termómetros Especiales para Microondas solamente Convencional	Si No	No No	Use solamente termómetros para carne y dulce especiales para microondas.
Papel Encerado	Si	No	Uselo como cubierta para prevenir salpicaduras y para retener la humedad.
Rejilla de Alambre	No	Si	Use solo el accesorio de rejilla de alambre incluido con este modelo de horno.

PARA PROBAR UN CONTENEDOR PARA EL USO SEGURO DEL HORNO DE MICROONDAS: Mida una taza de agua y viértala en el contenedor que se va a probar y pongalo en el horno de microondas, caliente un minuto en temperatura P10 (ALTO). Si el contenedor es especial para horno de microondas, permanecerá confortablemente frio y el agua debera éstar caliente. Si el contenedor esta caliente, ha absorbido alguna energía de microondas y no deberá ser usado. Esta prueba no puede ser hecha en contenedores de plástico.

Cuidado del horno de microondas

ANTES DE LIMPIAR:

Desenchufar en la toma mural del horno. En caso de que sea imposible, dejar la puerta del horno abierta para impedir que el horno se ponga en marcha de manera accidental.

DESPUÉS DE LIMPIAR:

Asegúrese de que se vuelve a colocar el Aro de Rodillo y la Bandeja de Cristal en la posición correcta, después pulsar la tecla Stop/Reset (Pausa/Cancelar) para borrar la pantalla.

Interior del horno:

Limpiar con un trapo húmedo. Se puede utilizar un detergente suave si el horno se ensucia mucho. No se recomienda el empleo de detergentes muy fuertes o abrasivos.

Bandeja de Cristal:

Extraer y lavar con agua jabonosa y tibia o en un lavaplatos.

Las superficies exteriores del horno.

Limpiar con un trapo suave. Para impedir daños en las piezas en operación en el interior del horno, no se debe permitir que el agua entre por las aperturas de ventilación.

Etiqueta de Menú:

No extraer. Limpiar con un trapo suave.

Panel de Control:

* Cubierta con una película protectora extraíble para impedir ralladuras durante el envío. (Consejo - Para extraer la película, aplicar cinta adhesiva transparente o de uso eléctrico en una esquina expuesta y tirar suavemente.)

* Si el panel de control se humedece, limpiar con un trapo seco y blando. No utilizar detergentes fuertes o abrasivos en el Panel de Control.

Aro de Rodillo y el suelo de la cavidad del horno:

Limpiar la superficie inferior del horno con agua con un detergente suave o un producto de limpieza de ventanas y secar. El aro de Rodillo se puede lavar con agua con un detergente suave o con un producto para la limpieza de ventanas. Estas zonas se deberán mantener limpias para así evitar un ruido excesivo.

Secundo Nivel de cocinado



Puerta de Horno:

* Limpiar con un trapo blando cuando el vapor se acumule en el interior o alrededor del exterior de la puerta del horno. Durante la cocción, especialmente bajo condiciones de mucha humedad, los alimentos expelen vapor. (Parte del vapor se condensará en las superficies más frías, como la puerta del horno. Esto es normal.)

* La superficie del interior está cubierta con una película que actúa como barrera contra el calor y el vapor. No extraer.

Diagrama de Características

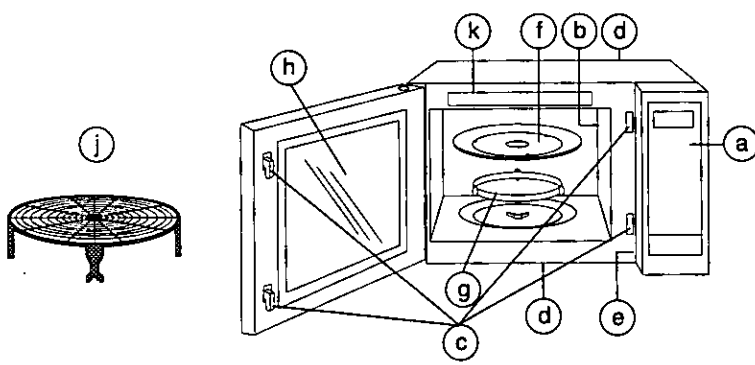

- (a) Panel de Control
- (b) Ventilaciones de Aire Internas
- (c) Sistema de Cierre de Seguridad de la Puerta
- (d) Ventilaciones de Aire Extremas
- (e) Placa de Identificación
- (f) Bandeja de Cristal
- (g) Aro de Rodillo
- (h) Película de Barrera contra el Calor/Vapor (no extra)
- (i) La rejilla de cocción de 2 niveles
- (k) Etiqueta de Menú

Panel de Control

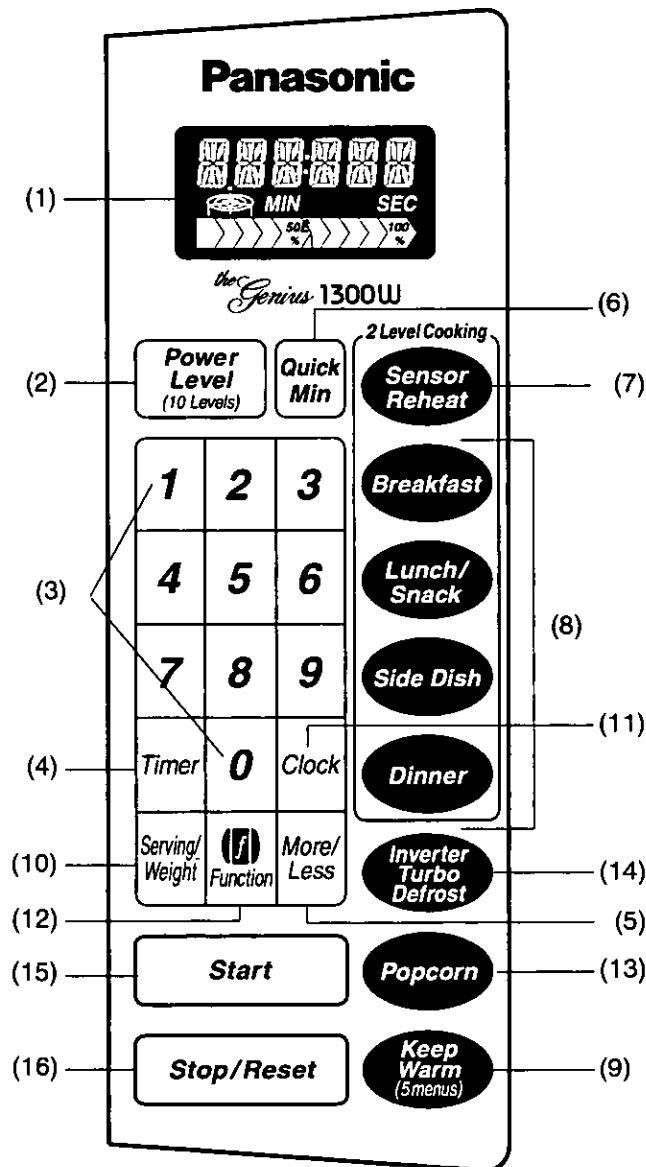

- (1) Pantalla indicadora (Ventana de Visualización)
- (2) Pulsador de potencia (☛page 10)
- (3) Pulsadores numéricos
- (4) Pulsador de tiempo (☛page 10)
- (5) Pulsador Más/Menos (☛page 12)
- (6) Pulsador rápido de minutos (☛page 9)
- (7) Pulsador Sensor de Recalentamiento (☛page 12)
- (8) Cocción por Sensor (☛page 12)
- (9) Pulsador de Mantener Caliente (☛page 9)
- (10) Pulsador de Porción/Peso (☛page 9)
- (11) Pulsador de Reloj (☛page 9)
- (12) Pulsador de Funciones Pad (☛page 8)
- (13) Pulsador de Palomita de maíz (☛page 11)
- (14) Descongelación Turbo Inverter (☛page 11)
- (15) Pulsador Para Comenzar
- (16) Pulsador Para Detener

Cómo utilizar las teclas de función

Esta función única de su horno de microondas PANASONIC le permitirá establecer las funciones iniciales que no son de cocción de su horno, tales como BLOQUEO PARA NIÑOS, VELOCIDAD DE PALABRAS, OPCIÓN DE IDIOMA (INGLÉS, FRANCÉS O ESPAÑOL) y muchas más. Consulte abajo:

1)		Pulsar: FUNCIÓN, el Mensaje de Acción del Menú es "Seleccionar Función 0 hasta 9 1--OPCIÓN DE IDIOMA...etc."
2)	Seleccionar un número (0 - 9) Ejemplo: SEGURO PARA NIÑOS es 5.	Presionar. El Mensaje de Acción del Menú es "5--SEGURO PARA NIÑOS SI/NO"
3)	Seleccionar 1,2 o 3.	Pulsar: Un número. Su selección es ahora parte del sistema operativo. Puede cambiar en cualquier momento.
4)	Continúe hasta que haya finalizado sus selecciones.	Consultar abajo para obtener otras opciones.



1	SELECCIÓN DE IDIOMA El horno posee una visualización en Inglés, Francés y Español. Cuando se enchufa por primera vez la visualización aparece en inglés. 1 ENGLISH → La visualización aparece en inglés. 2 FRANÇAIS → La visualización aparece en francés. 3 ESPANOL → La visualización aparece en español.
2	SELECCIÓN DE LIBRA/KILO Este horno posee mediciones de peso en el sistema inglés y en el sistema métrico. Cuando se enchufa, el horno el horno visualiza el peso en el sistema inglés. 1 Lb → El peso se puede ajustar en onzas/libras (Sistema Inglés) 2 kg → El peso se puede ajustar en g/kg (Sistema Métrico)
3	VELOCIDAD DE PALABRAS La velocidad del desplazamiento de palabras de la Ventana de Visualización se puede acelerar o retrasar. 1 RÁPIDO → Las palabras se desplazan rápidamente 2 MEDIO → La velocidad de desplazamiento vuelve a su ajuste inicial 3 DESPACIO → Las palabras se desplazan lentamente
4	ACCIÓN DE MENÚ La ventana de acción del menú le ayuda a programar su horno por medio indicar mediante mensajes-guías el próximo paso que se tiene que dar. Cuando se familiarice con su horno, la aparición de mensajes-guías se puede colocar en "OFF". 1 SI → Aparecerá la Guía del Mensaje-Guía 2 NO → No aparecerá la Guía del Mensaje-Guía
5	SEGURO PARA NIÑOS SI/NO El horno posee una función de Seguro para Niños que impide el uso de los hornos por parte de los niños. No cierra la puerta. 1 SI → Se ha ajustado Seguro para Niños y no se aceptará la operación 2 NO → Se ha anulado el Seguro para Niños
6	BEEP SI/NO Si desea que el horno funcione sin zumbidos, éste se puede eliminar. 1 SI → El sonido del zumbido se reactivará 2 NO → El sonido del zumbido no se escuchará
7	BEEP RECORDATORIO SI/NO Un zumbido recordatorio funciona para recordarle que se debe extraer los alimentos del horno, después de la finalización de la cocción. 1 SI → El sonido "beep" de recordatorio trabajará 2 NO → El sonido "beep" de recordatorio no trabajará
8	HORA DE VERANO SI/NO 1 SI → La hora del día se adelantará una hora 2 NO → La hora del día volverá a su ajuste original
9	RELOJ SI/NO La visualización del reloj se puede colocar en "OFF" 1 SI → La visualización del reloj aparecerá en la Ventana de Visualización 2 NO → La visualización del reloj no aparecerá en la Ventana de Visualización
0	MODO DE DEMOSTRACIÓN El modo demo está diseñado para la visualización de las tiendas minoristas. En este modo, el funcionamiento del horno se puede demostrar sin que éste tenga alimentación eléctrica. 1 SI → El horno está en modo demo 2 NO → El horno no está en modo demo

¡Vamos a empezar a usar su horno!

1. Acople en una toma eléctrica debidamente conectada a tierra.

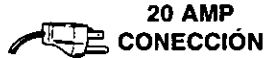

Ventana de Visualización



Las palabras "WELCOME TO PANASONIC -- REFER TO OPERATING INSTRUCTIONS BEFORE USE" aparecerán en la Ventana de Visualización.

2. Los mensajes de la Ventana de Visualización aparecen automáticamente en el idioma inglés.

Si desea utilizar **español** o francés, utilizar la opción de idioma de la tecla de Función.

Si desea utilizar mediciones métricas, utilizar la opción de peso de la tecla de Función.

Ventana de Visualización

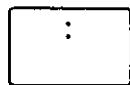

3. Al final de mensaje "WELCOME . . .", aparecen dos puntos en la Ventana de Visualización.

Ahora, disfrute cocinando con su microondas Panasonic.

Rápido en minutos

Esta función le permite ajustar y/o añadir tiempos de cocción fácilmente en múltiplos de un minuto.

Para Ajustar el Tiempo de Cocción:

Ejemplo: 5 minutos

1. **Quick Min** Ajustar tiempo de cocción. El nivel de potencia es P10 (ALTO).

Presione. (hasta 10)

Ventana de Visualización



2. **Encender** La cocción se inicia y se la cuenta atrás. La flecha de nivel de potencia inicia desplazamiento.

Presione.



Al final de la cocción, suenan cinco zumbidos. "DISFRUTE DE SUS ALIMENTOS" aparece en La Ventana de Visualización.



NOTAS:

1. Para utilizar con otros niveles de potencia, presionar Nivel de Potencia, a continuación Ajuste Rápido.
2. Si utiliza Ajuste Rápido, no podrá utilizar Teclas de Números o viceversa.
3. Pulsar Ajuste Rápido para añadir más tiempo durante la cocción. Para verificar el tiempo de cocción adicional, comprobar la Ventana de Visualización.

Reloj

Esta función le permite visualizar la hora. El horno funciona sin que sea necesario ajustar la hora.

Ejemplo: Para ajustar 12:34 AM o PM.

Ventana de Visualización

1. **Clock** Aparecen dos puntos y parpadean.

Presione.

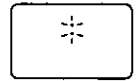

2.

1	2	3
4	5	6
7	8	9
	0	

 Introducir la hora utilizando las teclas de números. Los dos puntos continúan parpadeando.

"PRESIONE EL PULSADOR RELOJ" se desplaza a través de la Ventana de Visualización.

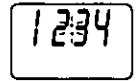

3. **Clock**

Pulsar Reloj otra vez para ajustar la hora.

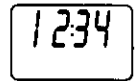

Los dos puntos dejan de parpadear.

NOTAS:

1. Para reiniciar el reloj. Repetir el paso 1 hasta el 3.
2. El Reloj seguirá marcando la hora siempre que siga recibiendo alimentación eléctrica.
3. El Reloj visualiza el horario normal basado en las 12 horas, no utiliza el horario militar.
4. El horno no funcionará mientras los dos puntos estén parpadeando.

Mantener Caliente

Esta función le ayuda a mantener caliente una selección de alimentos durante 30 minutos después de su cocción.

Ejemplo: Para mantener caliente 2 tazas de salsa de carne.

Ventana de Visualización

1. **Keep Warm** "CALDO ESPESO PRESIONE PORCIONES/ PESO" aparece en La Ventana de Visualización.

Presione dos vez.



2. **Serving Weight** Verificar el porción en la Ventana de Visualización.



3. **Start** El tiempo de Mantener Caliente aparece en la Ventana de Visualización y inicia la cuenta a atrás a partir desde 30 minutos.

Presione



Al final de la Mantener Caliente, se escuchan cinco zumbidos. En la Ventana de Visualización aparece "DISFRUTE DE SUS ALIMENTOS"









Operación Manual (Ajuste de Potencia y Tiempo)

Esta función le permite ajustar manualmente la potencia y tiempo para la cocción del microondas.

Presionar la tecla Nivel de Potencia hasta que la potencia deseada aparezca en la Ventana de Visualización. Consulte el Gráfico que aparece abajo.

Ejemplo: Para cocinar en P 5 durante 1 minuto 30 segundos.

-  "P 5 AJUSTAR EL TIEMPO" aparece en la Ventana de Visualización. Presione seis veces.
 
-  Introducir tiempo de cocción utilizando las teclas de número.
 
-  La Ventana de Visualización realiza una cuenta atrás y la flecha del nivel de potencia empieza a desplazarse. Presione.
 

Al final de la cocción, suenan cinco zumbidos. "DISFRUTE DE SUS ALIMENTOS" aparece en La Ventana de Visualización.

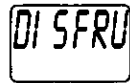

Pulsar Nivel de Potencia	Nivel de Potencia	Ventana de Visualización
una vez	P10 (ALTO)	
dos veces	P 9	
3 veces	P 8	
4 veces	P 7 (MEDIO-ALTO)	
5 veces	P 6 (MEDIO)	
6 veces	P 5	
7 veces	P 4	
8 veces	P3 (MEDIO-BAJODESC)	
9 veces	P 2	
10 veces	P 1 (BAJ)	

NOTAS:



- Para la cocción de más de una etapa, repetir los pasos, 1 y 2 para cada etapa de cocción antes de presionar la tecla **Start** (Encender). El número máximo de etapas es de 5.
- Cuando se selecciona la potencia P10 (ALTO) para la primera etapa, podrá empezar en el paso 2.
- Sonarán dos zumbidos entre cada etapa de la programación. Sonarán cinco zumbidos al final de toda la secuencia.
- Cuando se selecciona la potencia P10 (ALTO) el tiempo máximo es de 30 minutos.
- Para el recalentamiento, utilizar P10 (ALTO) para líquidos, P 7 (MEDIO-ALTO) para la mayoría de los alimentos y P 6 (MEDIO) para los alimentos densos.

Temporizador

Esta función le permite:

- Utilizarla como un TEMPORIZADOR de cocina.
- Programar tiempo de REPOSO una vez ha finalizado la cocción.
- Programar tiempo de RETARDO para iniciar la cocción.

Para Ajustar TEMPORIZADOR:

-  "TOMADOR DE TIEMPO - AJUSTE TIEMPO" Presione una vez.
-  Introducir el tiempo utilizando la teclas de Número (hasta 99 minutos y 99 segundos)

Ventana de Visualización



Para Activar el Programa del TEMPORIZADOR:

-  El Temporizador realizará la cuenta atrás. No se realizará ningún tipo de cocción. Presione.

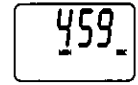

Al final del tiempo, se producirá 5 zumbidos, y "DISFRUTE DE SUS ALIMENTOS" aparece en la Ventana de Visualización.



NOTAS:

- Después de acabado cada etapa, se producen dos zumbidos. Al final del programa, el horno emitirá cinco zumbidos más.
- Si la puerta del horno se abre durante el tiempo de TEMPORIZADOR/RETARDO/REPOSE, el tiempo en la Ventana de Visualización continuará realizando su cuenta atrás.
- La Puesta en Marcha del RETARDO no se puede programar antes de ninguna Función de Control Automática. Esto tiene como fin impedir que la temperatura inicial de los alimentos aumente antes de que se inicie la descongelación o la cocción. Un cambio en la temperatura inicial tendría como resultado una cocción. Un cambio en la temperatura inicial tendría como resultado una cocción muy poco precisa.
- El temporizador se puede ajustar en 99 minutos y 99 segundos.

Para Ajustar el Tiempo de RETARDO*:

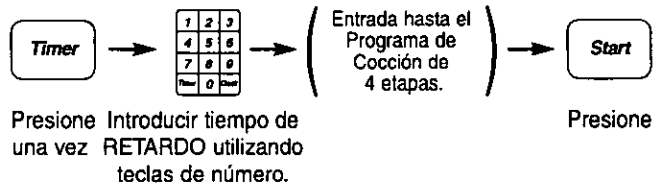

* La cocción empezará una vez finalizado el tiempo de RETARDO.

Para Ajustar el Tiempo de REPOSO*:

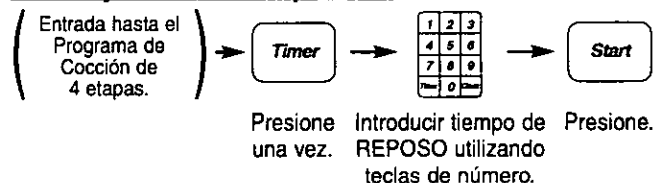

* El Tiempo de REPOSO iniciará la cuenta atrás después de que se realice la cocción.

Palomitas de maíz

Para su empleo con bolsas de palomitas de maíz ya preparadas y empaquetadas:

Ejemplo: Para cocinar un paquete de 3.5 onzas de palomitas de maíz de horno de microondas.

Ventana de Visualización

1.  "PALOMITAS PRESIONE ENCENDER" se desplaza a través de la Ventana de Visualización.

PRLOMI

Verificar el peso del paquete en la Ventana de Visualización.

3.5 OZ

2.  La cocción se inicia y se la cuenta atrás. La flecha de nivel de potencia inicia desplazamiento.

1.50

El nivel de potencia se desplaza.

1.49

Al final de la cocción, suenan cinco zumbidos. "DISFRUTE DE SUS ALIMENTOS" aparece en La Ventana de Visualización.

DISFRU

Pulsar tecla de de Palomitas de Maíz	Paquete de Palomitas de Maíz	Tiempo
una vez	1.75 oz. (50 g)	variará dependiendo del tamaño y potencia del horno.
dos veces	2.65 oz. (75 g)	
3 veces	2.85 oz. (80 g)	
4 veces	3.0 oz. (90 g)	
5 veces	3.5 oz. (99 g)	

NOTAS:

1. Los paquetes de palomitas de maíz deberían estar a temperatura ambiente.
2. Colocar la bolsa de acuerdo con las instrucciones del fabricante.
3. Cocinar las bolsas una a una.
4. Una vez que las palomitas estén ya cocinadas, permitir que la bolsa se enfríe. Abrir cuidadosamente la bolsa, manteniéndola apartada de la cara y del cuerpo, ya que las palomitas y el vapor están extremadamente calientes.
5. **NUNCA** deje el horno sin atención cuando prepare palomitas de maíz.
6. No recalentar nunca granos que no se hayan convertido en palomitas ni reutilizar la bolsa.
7. Debido a la gran variedad de palomitas de maíz para microondas en el mercado, tal vez sea necesario poner la bolsa en la orilla del plato giratorio para obtener mejores resultados.

NOTAS: Cuando ponemos varias bolsas de palomitas de maíz de la otra, el tiempo de cocción podría variar minimamente. Esto no afectara los resultados.

CUIDADO: Si las palomitas de maíz envasadas son de un peso diferente al peso recomendado, no utilizar los ajustes de palomitas de maíz predefinidos. Ajustar el Nivel de Potencia y la Tiempo de acuerdo con las instrucciones del fabricante.

Descongelación Turbo Inverter

Esta función le permite descongelar carne, productos avícolas y pescado con solo introducir el peso.

Ejemplo: Para descongelar 2.5 libras (1.1 kg) de carne.

Ventana de Visualización

1.  "DESCONGELACIÓN TURBO INVERTER AJUSTE EL PESO" aparece en la Ventana de Visualización.

DESCOM

Presione.

2.  Introducir el peso utilizando las teclas de número. (6.0 LB MAX)

2.5 LB

3.  Aparece "tiempo de descongelación"

1.033

Presione.

Ventana de Visualización realiza una cuenta atrás.

1.032

Al final de la descongelación suenan cinco zumbidos y "DISFRUTE DE SUS ALIMENTOS" aparece en la Ventana de Visualización.

DISFRU

*NOTA: El tiempo variará dependiendo del tamaño y de la potencia de su horno.

GRÁFICO DE CONVERSIÓN

Seguir este gráfico para convertir onzas o centenas de libra en décimas de onza.

Ejemplo: Si una pieza de carne congelada pesa 1 libra 14 onzas, el equivalente es 1.9 libras.

Onzas	Centenas de Onza	Décimas de Onza
0	.96 - .05	0.0
1 - 2	.06 - .15	0.1
3 - 4	.16 - .25	0.2
5	.26 - .35	0.3
6 - 7	.36 - .45	0.4
8	.46 - .55	0.5
9 - 10	.56 - .65	0.6
11 - 12	.66 - .75	0.7
13	.76 - .85	0.8
14 - 15	.86 - .95	0.9

Cocción por Sensor

La función le permite cocinar cualquier cantidad de alimentos con tan solo una pulsación. EL HORNO LO HACE TODO POR USTED.



Presione

"BREAKFAST-SELECCIONE PORCIÓN/PESO" aparece en la Ventana de Visualización.

Ventana de Visualización



Opcional*



Presione

"SENSOR" aparece en la Ventana de Visualización



Después de 2 beeps, la hora aparece en la Ventana de Visualización



Al final de la cocción, suenan cinco zumbidos, y "DISFRUTE DE SUS ALIMENTOS" aparece en la Ventana de Visualización.



Pulsador de *More/Less (MAS/MENOS)

Las preferencias en el grado de cocción de los alimentos varían en cada individuo, con este pulsador usted podrá decidir qué tipo de grado de cocción prefiere en sus alimentos. Usando este pulsador el Sensor automático puede ser ajustado para cocinar el alimento por más o menos tiempo. Si usted está satisfecho con los resultados de cocción del programa *Sensor Cook/Sensor Reheat*, no necesitará usar el control *Más/Menos*.

Un toque: más cocido con indicador "*More*" (Más)

Dos toques: menos cocido con indicador "*Less*" (Menos)

Tres toques: cocido inicial

Pulsar *More/Less* (Más/Menos) antes de pulsar *Start* (Encender)

Sensor de Recalentamiento

Ventana de Visualización

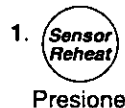

Presione

"RECALENTAMIENTO POR SENSOR - PRESIONE ENCENDER" se desplaza a través de la Ventana de Visualización.

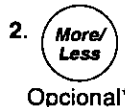

Opcional*



Opcional



Presione

"SENSOR" aparece en la Ventana de Visualización



Después de 2 beeps, la hora aparece en la Ventana de Visualización



Al final de la recalentamiento, suenan cinco zumbidos, "DISFRUTE DE SUS ALIMENTOS" aparece en la Ventana de Visualización.



Para obtener mejores resultados de Sensor de Recalentamiento, siga estas recomendaciones:

ANTES de cocinar/recalentar:

1. La temperatura ambiente que rodea al horno debe ser menor de 95° F (35° C).
2. El peso de los alimentos no deberá ser menor a 4 oz. (110 g).
3. El pisto giratorio de cristal y el contenedor que se va a utilizar deben estar secos.
4. Cubra los alimentos por completo con papel plástico procurando que este no quede muy adherido, o bien, colocarlo en una cacerola con tapa.
5. Todos los alimentos deben ser cocidos previamente y deben estar a temperatura o temperatura de refrigerador.

DURANTE la cocción/recalentado::

Mientras la palabra "SENSOR" se muestre en la Ventana de Visualización, no deberá abrirse la puerta del horno por más de 1 minuto, esto causaría resultados inadecuados en la cocción. El tiempo restante de cocción aparecerá inmediatamente en la Ventana de Visualización y comenzará a contar en forma descendente. El horno puede ser abierto durante este tiempo restante para voltear, batir o añadir ingredientes.

DESPUES de la cocción/recalentado:

Todos los alimentos deben estar cubiertos durante un tiempo de 3 a 5 minutos.

Consejos y Técnicas de Descongelación

Antes de Descongelar:

1. Congelar carnes, carne de ave y pescado en paquetes con solo 1 o 2 capas de alimentos. Colocar papel parafinado entre las capas.
2. Empaquetar en envoltorios de plástico resistentes (etiquetadas "Para Congelador") o papel de congelador.
3. Extraer tanto aire como sea posible, ejemplo: crear un vacío.
4. Cerrar bien el paquete, incluyendo fecha y etiqueta.

Para Descongelar:

1. Quitar el envoltorio. Esto ayuda a que la humedad se evapore. Los jugos de los alimentos se pueden calentar y cocer los alimentos.
2. Colocar los alimentos en la rejilla de asado segura del microondas, en un plato con un tamaño adecuado.
3. Colocar el lado de la grasa del asado hacia abajo. Colocar el lado de la pechuga del ave entera hacia abajo.
4. Extraer los líquidos durante la descongelación.
5. Girar (invertir) los productos durante la descongelación.
6. Proteger los bordes y los extremos en caso de que sea necesario. (Consultar "Técnicas de Cocción")
7. Seleccionar potencia y tiempo mínimo para que así los productos no se descongelen enteramente.

Después de la Descongelación:

1. Puede que los artículos grandes estén descongelados en el centro. La descongelación finalizará durante el TIEMPO DE REPOSO.
2. Dejar reposar, cubierto con la envoltura de plástico, en el frigorífico durante el tiempo que aparece en el gráfico que aparece abajo.
3. Consultar el gráfico que aparece abajo para obtener el tiempo de reposo y las instrucciones de enjuague.
4. Los artículos que se han dividido en capas se deben enjuagar por separado o deberán disponer de un tiempo de reposo más extendido.

Alimento	Tiempo de descongelación (min. por libras) (P 3)	Durante la descongelación	Después de la descongelación	
			Tiempo de reposo	Enjuagar (agua fría)
Pescado y Marisco (hasta 3 lb - 1.4 kg)				
Carne de cangrejo	6	Romper y separar/Reordenar	5 minutos	Sí
Bistecs de Pescado	4 a 6	Dar la vuelta		
Filetes de Pescado	4 a 6	Dar la vuelta/Reordenar/Proteger extremos		
Vieras Preparadas	4 a 6	Separar/Extraer trozos congelados		
Pescado entero	4 a 6	Dar la vuelta		
Carne				
Carne Picada	4 a 5	Dar la vuelta/Extraer parte descongelada/Proteger bordes	10 minutos	No
Asados (2½ - 4 lbs) (1.1-1.8 kg)	4 a 8	Dar la vuelta/Proteger extremos y superficie descongelada	30 minutos en frigorífico	
Chuletas/Bistec	6 a 8	Dar la vuelta/Volver a ordenar/Proteger extremos y superficie descongelada	5 minutos	
Costillas/Entrecot	6 a 8	Dar la vuelta/Volver a ordenar/Proteger extremos y superficie descongelada		
Carne de Cocido	4 a 8	Separar/Volver a ordenar/Extraer partes descongeladas		
Hígado (cortado finamente)	4 a 6	Extraer el líquido/Dar la vuelta/Separar piezas	---	
Tocino, rebanadas	4	Dar la vuelta	---	
Carne de Ave				
Pollo entero hasta 3 lbs (1.4 kg)	4 a 6	Dar la vuelta/Proteger	20 minutos en frigorífico	Sí
Cortes	4 a 6	Separar/Dar la vuelta/Extraer partes descongeladas	5 minutos	
Trozos	4 a 6	Separar/Dar la vuelta/Proteger	10 minutos	
Aves de Caza	6 a 8	Dar la vuelta/Proteger		
Pechuga de pavo 5 - 6 lbs (2.3 - 2.7 kg)	6	Dar la vuelta/Proteger	20 minutos en frigorífico	

Consejos Rápidos

ALIMENTOS	POTENCIA	TIEMPO (en minutos)	INSTRUCCIONES
Tocino, Separado, 500 g	P10	30 s	Quite la envoltura. Después de calentar, use una espátula de plástico para separar las rebanadas.
Azúcar Morena, Suavizada (250 mL)	P10	½ a ¾	Coloque 1 taza de azúcar morena en el plato con una rebanada de pan o un trozo de manzana. Cubra con envoltura plástica.
Manteca, Derretida, 100 g Manteca, Suavizada, 100 g	P 6 P 3	40 s a 1 1	Quita la envoltura y colocar la manteca en un plato de seguridad para microondas.
Chocolate, Derretido, 1 cuadro (30 g) Chocolate, Derretido, ½ taza de chispas	P10 P10	1 a 1½ 1 a 1½	Quite la envoltura y coloque el chocolate en el plato, remueva antes de añadir más tiempo. El chocolate conserva su forma aun cuando se suaviza.
Coco, Pan Tostado, ½ tazas (125 mL)	P10	1 a 2	Coloquelos en un molde de tarta o en tazón. Remueva cada 30 segundos.
Queso Crema, Suavizado, 250 g	P3	1 a 2	Quite la envoltura y colóquelo en un plato.
Taza de agua 1 taza (250 g) 2 tazas (500 g) Taza de leche 1 taza (250 g) 2 tazas (500 g)	P10 P10 P 7 P 7	2 a 3 4 2 a 3 4 a 5	Los líquidos calientes pueden hacer erupción si no son mezclados con aire. No caliente líquidos en su horno de microondas sin removerlos primero.
Consomé de Res, 500 g	P10	4 a 7	Paselo por un colador de seguridad para microondas colocado en otro plato. Remover dos veces.
Helado, Suavizado, 2 litros	P 3	2 a 3	—————
Nueces, Rostizadas ½ tazas	P10	2 a 4	Extienda las nueces en un molde de pay de 23 cm. Remueva dos veces.
Semillas de Girasol, Tostadas, ¼ taza	P10	2½ a 4	Coloque en una taza pequeña. Remueva dos veces.
Para Quitar Olores del Horno	P10	5	Combine 1 a 1½ tazas de agua con el jugo y piel de un limón en una taza pequeña. Después de calentar, limpie el interior del horno con una tela suave.

Antes de Solicitar Servicio Técnico

Todas estas cosas son normales:

El horno provoca interferencias en mi aparato de televisión.	Se puede producir algo de interferencia en la radio y en la televisión durante el empleo del horno de microondas. Esta interferencia es similar a la interferencia provocada por pequeños electrodomésticos, tales como mezcladoras aspiradoras, secadores de pelo, etc. No indica que existe ningún tipo de problema con su horno.
La luz del horno pierde intensidad.	Cuando se cocina con potencias diferentes a P10 (ALTO), el horno debe realizar su ciclo hasta obtener los niveles de potencia más bajos. La luz del horno perderá intensidad y se podrán escuchar sonidos de chasquidos cuando el horno realice su ciclo.
Se acumula vapor en la puerta del horno y aire caliente sale de las rejillas de ventilación.	Durante la cocción los alimentos despiden vapor. La mayoría de este vapor es removido por el aire que circula en la cavidad del horno, sin embargo, algo de vapor se condensará en las superficies frías tales como la puerta del horno. Esto es normal.
Utilicé accidentalmente mi horno de microondas sin ningún alimento en su interior	El utilizar el horno sin nada dentro durante un período breve no dañará el horno. No obstante, no recomendamos utilizar el horno de microondas sin ningún alimento en su interior.

PROBLEMA

CAUSA POSIBLE

ACCIÓN

El horno no se pone en marcha.	→ El horno no está enchufado con seguridad.	Extraer el enchufe de la toma, esperar 10 segundos y después volver a enchufar.
	→ El magnetotérmico o el fusible se ha fundido o disparado.	Reinicializar el magnetotérmico o cambiar el fusible.
	→ Existe un problema con la toma eléctrica.	Enchufar otro electrodoméstico en la toma para comprobar si ésta funciona correctamente.
El horno no empieza a cocinar.	→ La puerta no está cerrada completamente	Cerrar bien la puerta del horno.
	→ La tecla Encender no se presionó después de la programación.	Presione Encender.
	→ Ya se había introducido otro programa en el horno.	Presione Pausa/Cancelar para anular el programa anterior e introducir un programa nuevo.
	→ El programa no es correcto.	Programar otra vez de acuerdo con las Instrucciones de Operación.
	→ La tecla Pausa/Cancelar se presionó accidentalmente.	Programar el horno otra vez.
La palabra "DEMO" aparece en la Ventana de Visualización.	→ El MODO DEMO ha sido activado.	Desactivar el MODO DEMO utilizando la tecla de Función. Consultar Cómo utilizar la Tecla de Función.
La Bandeja de Cristal bascula.	→ La Bandeja de Cristal no está colocada correctamente en el Aro(s) del Rodillo o existen alimentos debajo del Aro(s) del Rodillo.	Limpiar de acuerdo con Cuidado de su Horno Microondas.
Cuando el horno está funcionando, la Bandeja de Cristal produce ruidos.	→ El Anillo(s) del Rodillo y el fondo del horno están sucios.	Limpiar de acuerdo con Cuidado de su Horno Microondas.

NOTAS

NOTES